

BEFORE YOU BEGIN

1. Install all drivers and tape in accordance with national and local electrical codes and building standards.
2. In all cases, GM Lighting recommends that you hire or consult with a licensed and qualified electrician or electrical contractor.
3. Do not modify this product. Modifying or mounting this product outside of the directions in this installation guide will void the warranty and may result in injury.
4. Please adhere to Dry and Damp location use restrictions. Dry and Damp locations mean the areas will not get wet but may have moisture in the air. Do not install these products within five feet of swimming pool or spa.
5. Only install with GM Lighting **LineDRIVE** DC LED drivers. Using other drivers voids 5-year warranty.
6. Some wattage profiles require installation into GM Lighting LED mounting channels for proper heat control.
7. To avoid voltage drop, ensure that wire gauge used is sufficient to keep under 3% voltage drop.
8. Do not exceed maximum run listed for each tape type, and for power supply (per circuit on dual circuit models).
9. Cut at designated cut points only (**FIG. 1**). Cutting anywhere else will result in damage to the LED tape and will void warranty.
10. Use GM Lighting approved **SureTite™** or **EZ Connectors** for field connections. Contact GM Lighting for soldered connections.
11. Proper installation will ensure many years of successful usage. Failure to follow safety warnings and instructions will void warranty.

FIG. 1

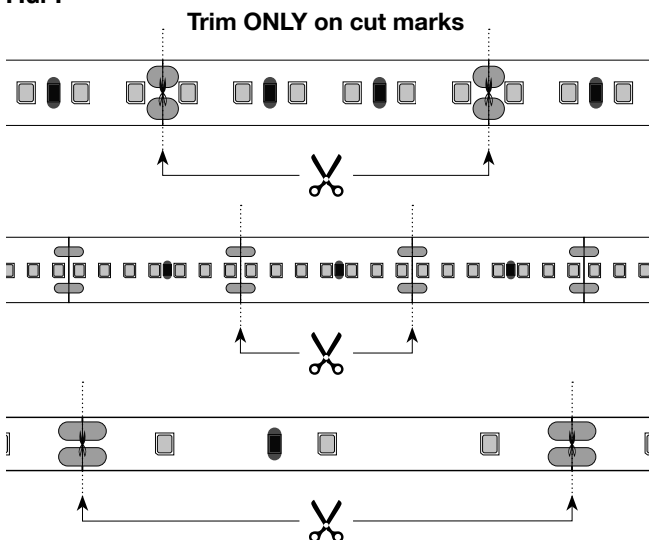

TOOLS NEEDED:

- Phillips screwdriver
- Tape measure
- Marking pen/pencil
- Wire strippers
- Scissors
- Wire connectors

PARTS INCLUDED:

- 1 Reel of **LTR LED Tape**

OPTIONAL PARTS:

- 18-2-WIRE in-wall rated cable
- 12VDC or 24VDC Power Supply
- Aluminum Mounting Channel

WARNING!

DO NOT CONNECT DIRECTLY TO 120V CURRENT!
PLEASE READ PREVIOUS PAGE AND FAMILIARIZE YOURSELF WITH ALL INSTRUCTIONS BEFORE INSTALLING

Dry and Damp Location

Dry and Damp location is a designation that usually means 'indoor'. **LTR Series** dry location tape is presented in a copper bus that is not encapsulated with a silicone sheath. To ensure proper operation, install only in locations that are not exposed to water, steam, inclement weather or leaks of any type.

Turn Power Off at Circuit Breaker Before Installing

Prior to installation, verify that all components (LED tape, connectors, mounting clips, channels and power supplies) are compatible. Verify that power is off before proceeding.

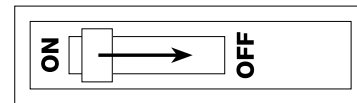

Determine Location and Prepare Mounting Surface

Locate area where **LineDRIVE** power supply is to be mounted. Make sure area is clean and free of dust and any debris that may hamper installation or get in the way of wiring. Please make sure that the wire gauge that you select has voltage drop, amperage rating and type (in-wall, dry or wet location, etc.) factored in

See the GM Voltage Drop Guide for more information.

Layout and Pre-Configure Components Before You Begin Installation

Locate area where **LineDRIVE** power supply is to be mounted. Make sure that this space is free of obstructions and can be easily reached for mounting or maintenance.

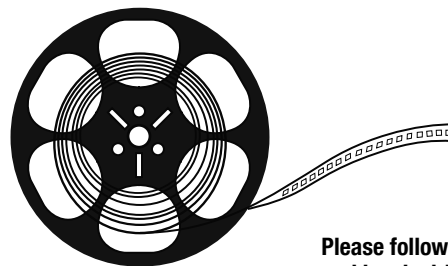

Please follow all applicable NEC and local wiring codes.

Follow maximum length requirements when using tape.

Max. Length = maximum run length from one power feed.

Cutting Tape

LED tape is unique in the fact that it is the only lighting 'fixture' that you can cut to length with only a pair of scissors. We made it easy for you to do that! Find the cut mark closest to your desired length and cut cleanly, across the marks. **(Fig. 1)**

Peel back adhesive 1/2" to expose back of tape. You are now ready for attaching a connector **(Fig. 2)**. If you're at the end of your run, you're done.

Attaching Connector

Using **Sure-Tite** connector (ST or EST Series) loosen screws at end of connector. Slide tape in firmly, pushing it all the way until it stops. Make sure that tape is seated firmly, creating a tight bond with the connector. Snug-tight screws, do not overtighten. **(Fig. 3)**.

Using EZ Connector

EZ connectors enable a tool-less connection, and is extremely simple to use. Simply pry open end, exposing the terminals. Slide tape into opening making sure that tape is captured by terminals. **(Fig. 3)**. Close lid until it snaps into place.

Attaching Power to Tape Connector

Use same procedure for connecting **Sure-Tite** connector. The other end of connector is wired into your **LineDRIVE** power supply. Please consult power supply instructions for a step by step for this easy procedure. Make sure that you are connected to the same polarity.

Warning

Make sure that tape is pressed firmly into connector, insuring that tape contacts are firmly seated into connector. Improper or loose seating can cause tape to short out or not perform properly.

Test tape installation by powering up before permanently mounting.

FIG. 1

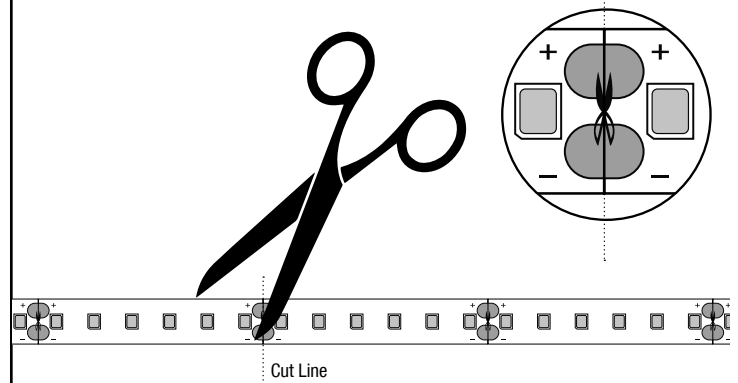

FIG. 2

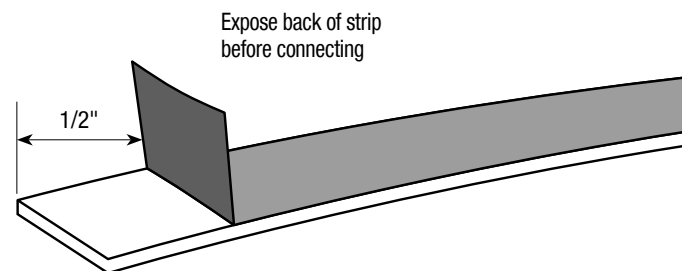
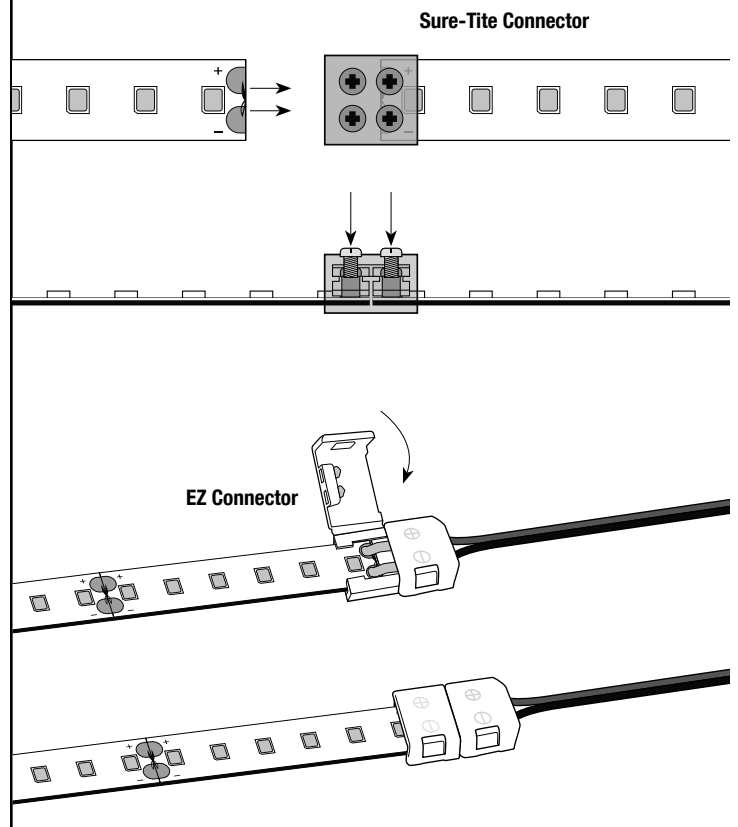

FIG. 3



Mounting Tape

As described, tape can be mounted either by adhesive tape backing, or by channel. In some cases, we require channel mounting for proper heat dissipation. **Dust will hamper adhesion. Wear protection, do not breathe in fumes. Clean and dry all surfaces thoroughly. (Fig. 4).** The following strips require mounting in channel.

All Tapes must be less or equal to Max. Run Lengths listed.

LTR-E 1.5W 12V Series - 32'-8" max.

LTR-E 1.5W 24V Series - 32'-8" max.

LTR-P 1.5W 12V Series - 32'-8" max.

LTR-P 1.5W 24V Series - 60' max.

LTR-P 3W 12V Series - 16'-4" max.

LTR-P 3W 24V Series - 32'-8" max.

LTR-P 4.5W 24V Series - 20' max.

LTR-P 5.8W 24V Series - 16'-4" max.

LTR-S 2.5W 24V Series - 32'-8" max.

LTR-S 5.8W 24V Series - 16'-4" max.

LTR-S 8W 24V Series - 12' max.

LTR-S-COB 1.5W 24V Series - 32'-8" max.

LTR-S-COB 3W 24V Series - 16'-4" max.

LTR-S-TW 2.2W 12V Series - 16'-4" max.

Peel back adhesive 1/2" to expose back of tape. You are now ready for attaching a connector (Fig. 5). If you're at the end of your run, you're done.

Using Mounting Channels

We offer a complete line of architectural quality aluminum extruded mounting channels and lenses in both 4' and 8' lengths. In measuring out a channel for your installation, take note that not all channels accept connectors within them. Best to make your connections outside of the channel. **Cut channels with the lens fitting down to avoid shattering.**

Cut channel using a metal blade in a circular saw or with a hacksaw. Make sure you observe all proper safety precautions and wear protective goggles. If using a hacksaw, ensure that channel is tightly clamped to work bench. (Fig. 6).

Mount channels using counter sunk screws. Sink screw every 12" along length of channel. (Fig. 7).

Lay tape in using adhesive backing to adhere tape to channel. Press firmly along length of tape. Do not apply a roller to tape as this may damage diodes. (Fig. 8).

Snap lens into channel, working from one end to the other. Lens will seat into channel with an audible snapping sound.

FIG. 4

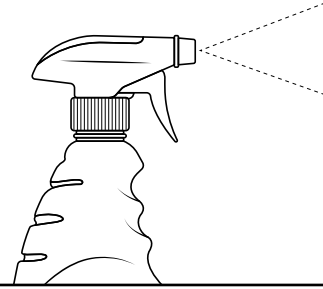

FIG. 5

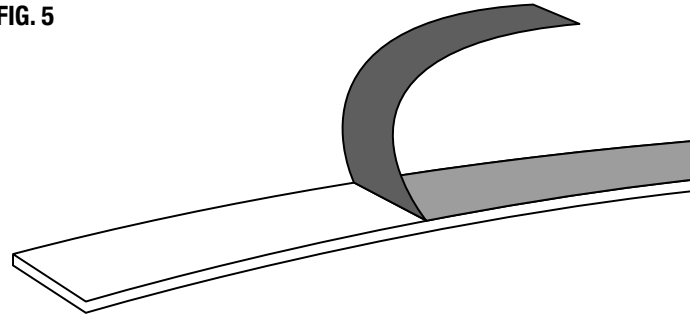

FIG. 6

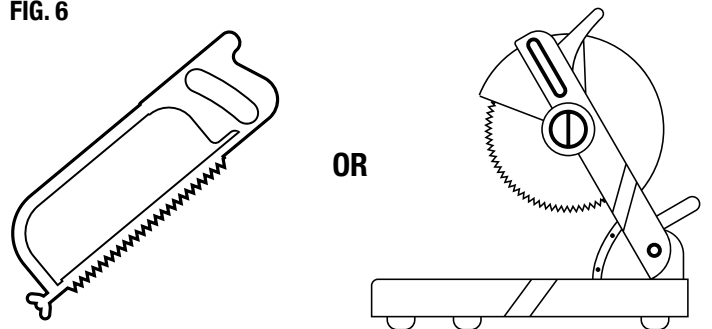

FIG. 7

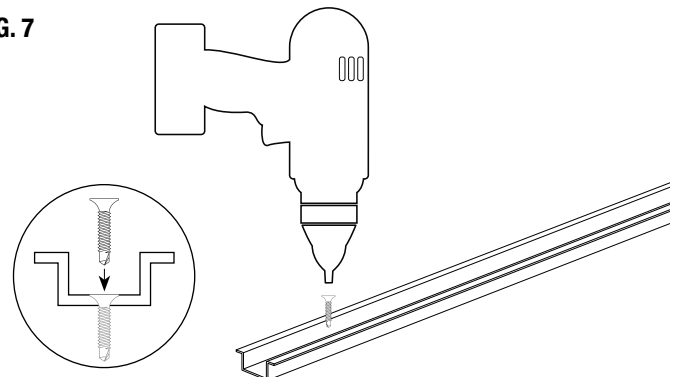
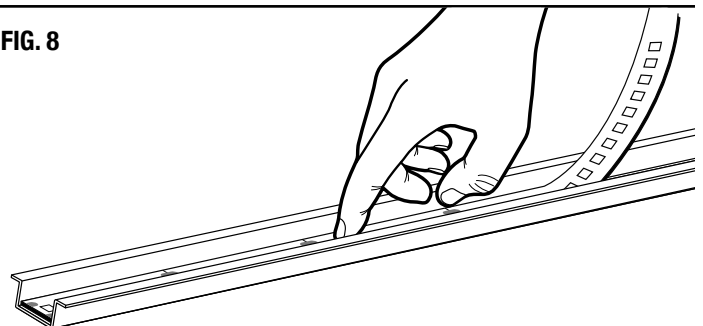
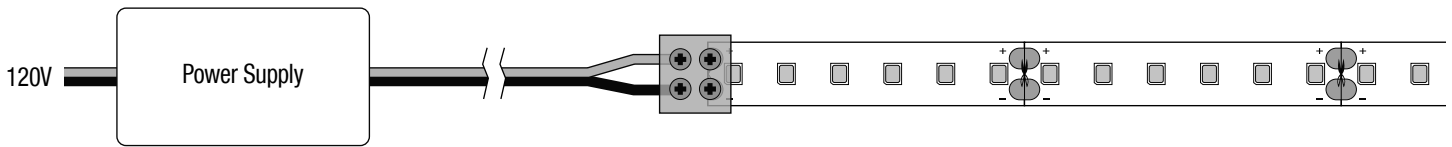

FIG. 8



Typical Application Set-Up and Wiring Diagrams

Connection at Power Supply:
For Single Run



Connection at Power Supply:
For Added Runs

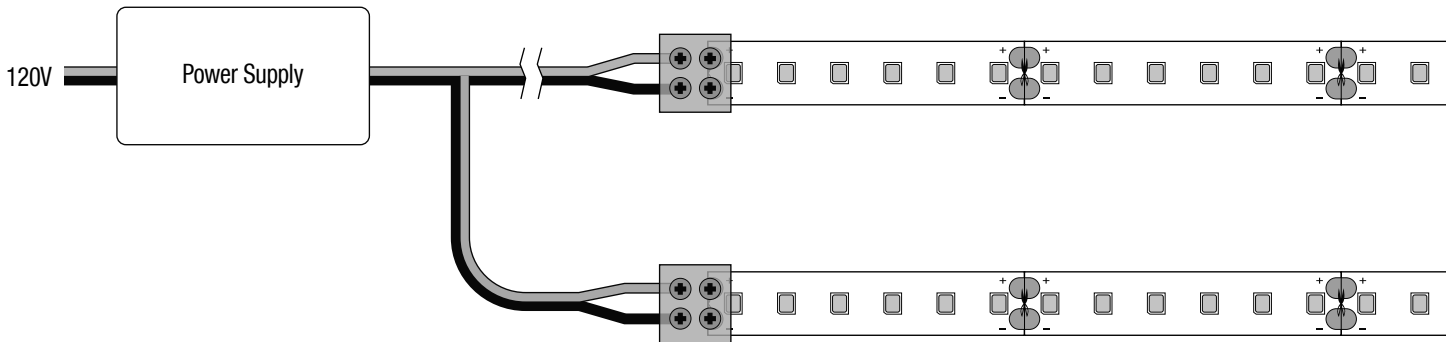

End-On-End Connection at Tape:

