

LTR-P Professional Series

4.5W, 24VDC LED Tape Specification Sheet



Project Name	Type
Catalog #	Date

PRODUCT OVERVIEW

GM's Professional Series Flexible LED Tape combines style and technology with reliability. Designed for professional installations that demand a high level of quality, the LTR-P Series includes a wide array of key features and is available in 16'-4" (5M) and 100' (30M) reels.

FEATURES

- 24VDC models
- 2400K, 2700K, 3000K, 3500K, 4000K and 5000K color temps
- Remote control with GM's LUXcontrol™ App and controllers
- Dry location
- 120 LEDs per meter
- Cuttable every 2"
- Custom lengths available - consult factory
- Premium diodes
- 120° viewing angle
- Dimmable
- 3M adhesive back
- Maximum run on a given lead is 20'
- Includes Sure-Tite connectors

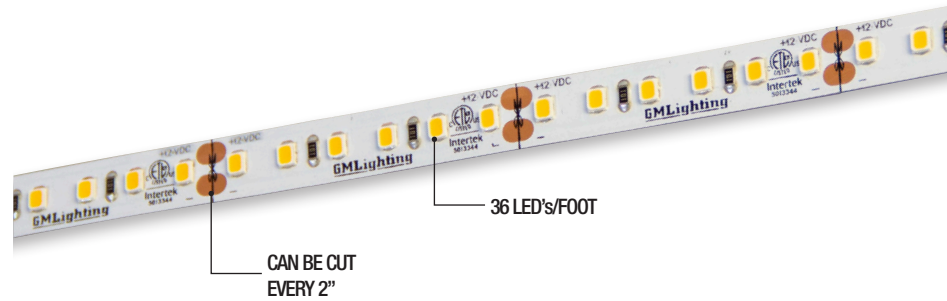

SPECIFICATIONS

ELECTRICAL

- 24V
- 4.5 watts per foot

OPTICS

- 90+ CRI

OPERATING TEMP

- -4°F to 122°F
- For proper thermal management, we recommend to mount this product in a channel

CERTIFICATION

- ETL
- Title 24 compliant when used with used with specific drivers. Consult factory.
- Class 2

WARRANTY

- 5-year warranty when paired with GM power supply

Note: Do not install in an application that is not easily accessed for service. Our warranty covers product only and does not cover any labor or incidental charges related to service or warranty.

ORDERING INFORMATION

Example: LTR-P-24V-4.5W-24K-16

Model	Series	Voltage	Wattage	Color Temp	Reel Length
LTR	P	24V	4.5W	24K	16
				27K	
				30K	
				35K	100
				40K	
				50K	

*Reel Length: 16 = 16'-4", 100 = 98'-6"

ACCESSORIES

Model	Description
ESTC-1	Sure-Tite tape to tape connector
ESTC-90	Sure-Tite 90° connector
ESTLK-60	Sure-Tite 60" adjustable tape to tape connector
ESTW-60	Sure-Tite 60" adjustable tape to power connector
ESTW-CO	Sure-Tite tape to power supply connector (no wire)

Your LED Tape Specification Checklist:

1. Select Tape
2. Select Connectors
3. Select Channels
4. Select Controllers or Dimmers
5. Select Power Supplies

Install Sheet



LTR-P Professional Series

4.5W, 24VDC LED Tape Specification Sheet



Catalog No.	Length	Lumens	CRI	Color Temp.	Max. Run
LTR-P-24V-4.5W-24K-16	16'-4" / 5M	317	90+	2400K	20'
LTR-P-24V-4.5W-27K-16	16'-4" / 5M	337	90+	2700K	20'
LTR-P-24V-4.5W-30K-16	16'-4" / 5M	334	90+	3000K	20'
LTR-P-24V-4.5W-35K-16	16'-4" / 5M	374	90+	3500K	20'
LTR-P-24V-4.5W-40K-16	16'-4" / 5M	387	90+	4000K	20'
LTR-P-24V-4.5W-50K-16	16'-4" / 5M	395	90+	5000K	20'
LTR-P-24V-4.5W-24K-100	98'-6" / 30M	317	90+	2400K	20'
LTR-P-24V-4.5W-27K-100	98'-6" / 30M	337	90+	2700K	20'
LTR-P-24V-4.5W-30K-100	98'-6" / 30M	334	90+	3000K	20'
LTR-P-24V-4.5W-35K-100	98'-6" / 30M	374	90+	3500K	20'
LTR-P-24V-4.5W-40K-100	98'-6" / 30M	387	90+	4000K	20'
LTR-P-24V-4.5W-50K-100	98'-6" / 30M	395	90+	5000K	20'

Kelvin temperature (color) ±100K.

16'-4" and 100' reel includes 48" lead affixed to tape. 16'-4" reel includes (3) ESTW-60 Sure-Tite connectors. 100' reel includes (10) ESTW-60 Sure-Tite connectors

COMPATIBLE CONTROLLERS

Model	Description
SHWC	LUXcontrol Smart 2.4 GHz WiFi Controller, Standard 12V/24V Low Voltage, see page 8
SHWD	LUXcontrol Smart 2.4 GHz WiFi Dimmer, Standard 12V/24V Low Voltage, see page 8
SWD-40W-12VDC-DIM	SwitchLD All-in-One Dimmer and Driver, 40W, 12VDC see page 10
SWD-60W-12VDC-DIM	SwitchLD All-in-One Dimmer and Driver, 60W, 12VDC see page 10
SWD-60W-24VDC-DIM	SwitchLD All-in-One Dimmer and Driver, 60W, 24VDC see page 10
SWD-100W-24VDC-DIM	SwitchLD All-in-One Dimmer and Driver, 100W, 24VDC see page 10

RECOMMENDED DRIVERS

Catalog No.	Description	Watts	Specification Sheet
LD-XD-UNV	LineDrive Electronic Multi-Dimmable Power Supply, 12VDC or 24VDC	20W, 40W, 60W, 96W, 180W, 200W, 300W	View Spec Sheet
LD-E-UNV	LineDrive Electronic Non-Dimmable Power Supply, 12VDC or 24VDC	30W, 60W, 96W, 200W, 300W	View Spec Sheet
LD-MD-UNV	LineDrive Magnetic Dimmable Power Supply, 12VDC or 24VDC	30W, 60W, 96W, 150W, 200W, 300W	View Spec Sheet
LD-EDM	LineDrive Electronic Dimmable MINI Power Supply, 12VDC or 24VDC	60W	View Spec Sheet
LTP	Cord and Plug Power Supply, 12VDC or 24VDC	25W, 48W, 60W, 90W	View Spec Sheet
PSD	Electronic Dimmable Power Supply, 12VDC or 24VDC	15W, 24W, 60W, 90W	View Spec Sheet

Please see our website for updated power supply specifications and information.

LTR-P Professional Series

4.5W, 24VDC LED Tape Specification Sheet



DIMENSIONS

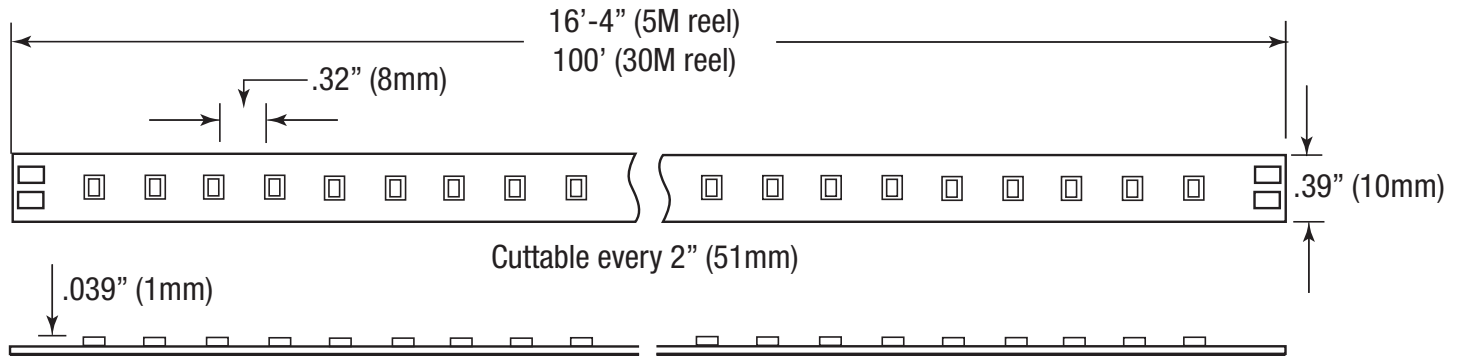

EST SERIES CONNECTORS

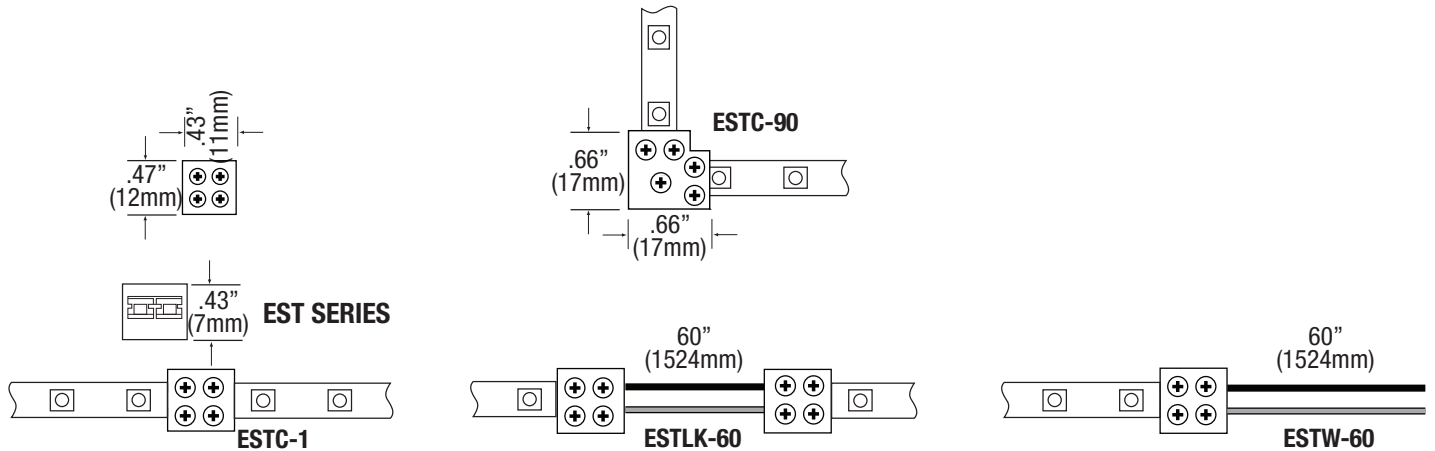

COMPATIBLE CHANNELS - FIT CONNECTORS ON PG. 1

EXTRA DEEP

Catalog No.	Description	Length	Dimensions
LED-CHL-XD	Extra deep format extruded channel. Includes snap-on frosted lens with mounting clips and screws.	4'	
LED-CHL-XD-8	Extra deep format extruded channel. Includes snap-on frosted lens with mounting clips and screws.	8'	
LED-CHL-XD-AMC	(2) Adjustable mounting brackets for LED-CHL-XD	N/A	
LED-CHL-XD-EC	(2) End caps for LED-CHL-XD. One solid, one with hole.	N/A	
LED-CHL-XD-MC	(2) Mounting clips and screws for LED-CHL-XD	N/A	

EXTRA DEEP FLANGED

LED-CHL-XD-F	Extra deep format extruded channel with flange. Includes snap-on frosted lens with mounting clips and screws.	4'	
LED-CHL-XD-F-8	Extra deep format extruded channel with flange. Includes snap-on frosted lens with mounting clips and screws.	8'	
LED-CHL-XD-F-DC	(2) Drywall mounting brackets for LED-CHL-XD-F	N/A	
LED-CHL-XD-F-EC	(2) End caps for LED-CHL-XD-F. One solid, one with hole.	N/A	

LTR-P Professional Series

4.5W, 24VDC LED Tape Specification Sheet



MINI DEEP

LED-CHL-XD-MD	Mini deep format extruded channel. Includes snap-on frosted lens with mounting clips and screws.	4'
LED-CHL-XD-MD-WH	Mini deep format extruded channel. Includes snap-on frosted lens with mounting clips and screws. White.	4'
LED-CHL-XD-MD-B	Mini deep format extruded channel. Includes snap-on frosted lens with mounting clips and screws. Black.	4'
LED-CHL-XD-MD-8	Mini deep format extruded channel with flange. Includes snap-on frosted lens with mounting clips and screws.	8'
LED-CHL-XD-MD-8-WH	Mini deep format extruded channel. Includes snap-on frosted lens with mounting clips and screws. White.	8'
LED-CHL-XD-MD-8-B	Mini deep format extruded channel. Includes snap-on frosted lens with mounting clips and screws. Black.	8'
LED-CHL-XD-MD-AMC	(2) Adjustable mounting brackets for LED-CHL-XD-MD	N/A
LED-CHL-XD-MD-EC	(2) End caps for LED-CHL-XD-MD. One solid, one with hole.	N/A
LED-CHL-XD-MD-MC	(2) Mounting clips for LED-CHL-XD-MD	N/A

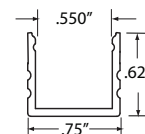

MINI DEEP FLANGED

LED-CHL-XD-MD-F	Mini deep format flanged extruded channel with flange. Includes snap-on frosted lens with mounting clips and screws.	4'
LED-CHL-XD-MD-F-WH	Mini deep format flanged extruded channel with flange. Includes snap-on frosted lens with mounting clips and screws. White.	4'
LED-CHL-XD-MD-F-B	Mini deep format flanged extruded channel with flange. Includes snap-on frosted lens with mounting clips and screws. Black.	4'
LED-CHL-XD-MD-F-8	Mini deep format extruded flanged channel with flange. Includes snap-on frosted lens with mounting clips and screws.	8'
LED-CHL-XD-MD-F-8-WH	Mini deep format extruded flanged channel with flange. Includes snap-on frosted lens with mounting clips and screws. White.	8'
LED-CHL-XD-MD-F-8-B	Mini deep format extruded flanged channel with flange. Includes snap-on frosted lens with mounting clips and screws. Black.	8'
LED-CHL-XD-MD-F-DC	(2) Drywall mounting brackets for LED-CHL-XD-MD-F	N/A
LED-CHL-XD-MD-F-EC	(2) End caps for LED-CHL-XD-MD-F One solid, one with hole.	N/A

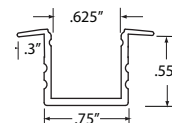

COMPATIBLE CHANNELS- FIT CONNECTORS ON PG. 1

45° ANGLE

Catalog No.	Description	Dimensions
LED-CHL-45	Extruded angled (45°) channel. Includes snap-on frosted lens with mounting clips and screws.	4'
LED-CHL-45-EC	(2) End caps for LED-CHL-45 - one solid, one with hole	N/A
LED-CHL-45-MC	(2) Mounting clips and screws for LED-CHL-45	N/A

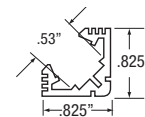

45° LARGE ANGLE

LED-CHL-45-1200	Extruded angled (45°) channel. Includes snap-on frosted lens with mounting clips and screws.	4'
LED-CHL-45-1200-EC	(2) End caps for LED-CHL-45 - one solid, one with hole	N/A
LED-CHL-45-1200-MC	(2) Additional mounting clips for LED-CHL-45-1200	N/A

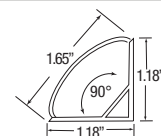

LTR-P Professional Series

4.5W, 24VDC LED Tape Specification Sheet



MUD IN - STANDARD

Catalog No.	Description		Dimensions
LED-CHL-MI-ST8	8ft. Standard extruded aluminum mud-in channel. Includes snap-on frosted lens.	8'	
LED-CHL-MI-ST-EC	(2) End caps for LED-CHL-MI-ST8 one solid, one with hole.	N/A	

WIDE

LED-CHL-W	Wide format extruded channel. Includes snap-on frosted lens with mounting clips and screws.	4'	
LED-CHL-W-8	Wide format extruded channel. Includes snap-on frosted lens with mounting clips and screws.	8'	
LED-CHL-W-AMC	(2) Adjustable mounting brackets for LED-CHL-W	N/A	
LED-CHL-W-EC	(2) End caps for LED-CHL-W - one solid, one with hole.	N/A	
LED-CHL-W-MC	(2) Additional mounting clips for LED-CHL-W	N/A	

STANDARD STRAIGHT

LED-CHL2-4	4ft Standard channel, 4ft white lens (2) mounting clips, (2) screws	4'	
LED-CHL2-6	6ft Standard channel, 6ft white lens, (4) mounting clips, (4) screws	6'	
LED-CHL2-ECG	(2) End caps for LED-CHL2: light gray, one solid, one with hole	N/A	
LED-CHL2-MC	(2) Mounting clips and (2) screws	N/A	
LED-CHL2-AMC	(2) Adjustable mounting clips and (2) screws	N/A	

COMPATIBLE CHANNELS - SOLDERED LEADS ONLY

STANDARD STRAIGHT

Catalog No.	Description		Dimensions
LED-CHL	Extruded channel. Includes snap-on frosted lens with mounting clips and screws.	4'	
LED-CHL-8	Extruded channel. Includes snap-on frosted lens with mounting clips and screws.	8'	
LED-CHL-AMC	(2) Adjustable mounting brackets for LED-CHL	N/A	
LED-CHL-EC	(2) End caps for LED-CHL - one solid, one with hole.	N/A	
LED-CHL-MC	(2) Additional mounting clips for LED-CHL	N/A	

45° MINI ANGLE

LED-CHL-45-MINI	Extruded angled (45°) silver channel. Includes white snap-on lens with (2) mounting clips and (2) screws.	4'	
LED-CHL-45-MINI-EC	(2) End caps for LED-CHL-45-MINI light gray, one solid, one with hole	N/A	
LED-CHL-45-MINI-MC	(2) Mounting clips and (2) screws for LED-CHL-45-MINI	N/A	

LTR-P Professional Series

4.5W, 24VDC LED Tape Specification Sheet



SHWC LUXCONTROL WIFI CONTROLLER

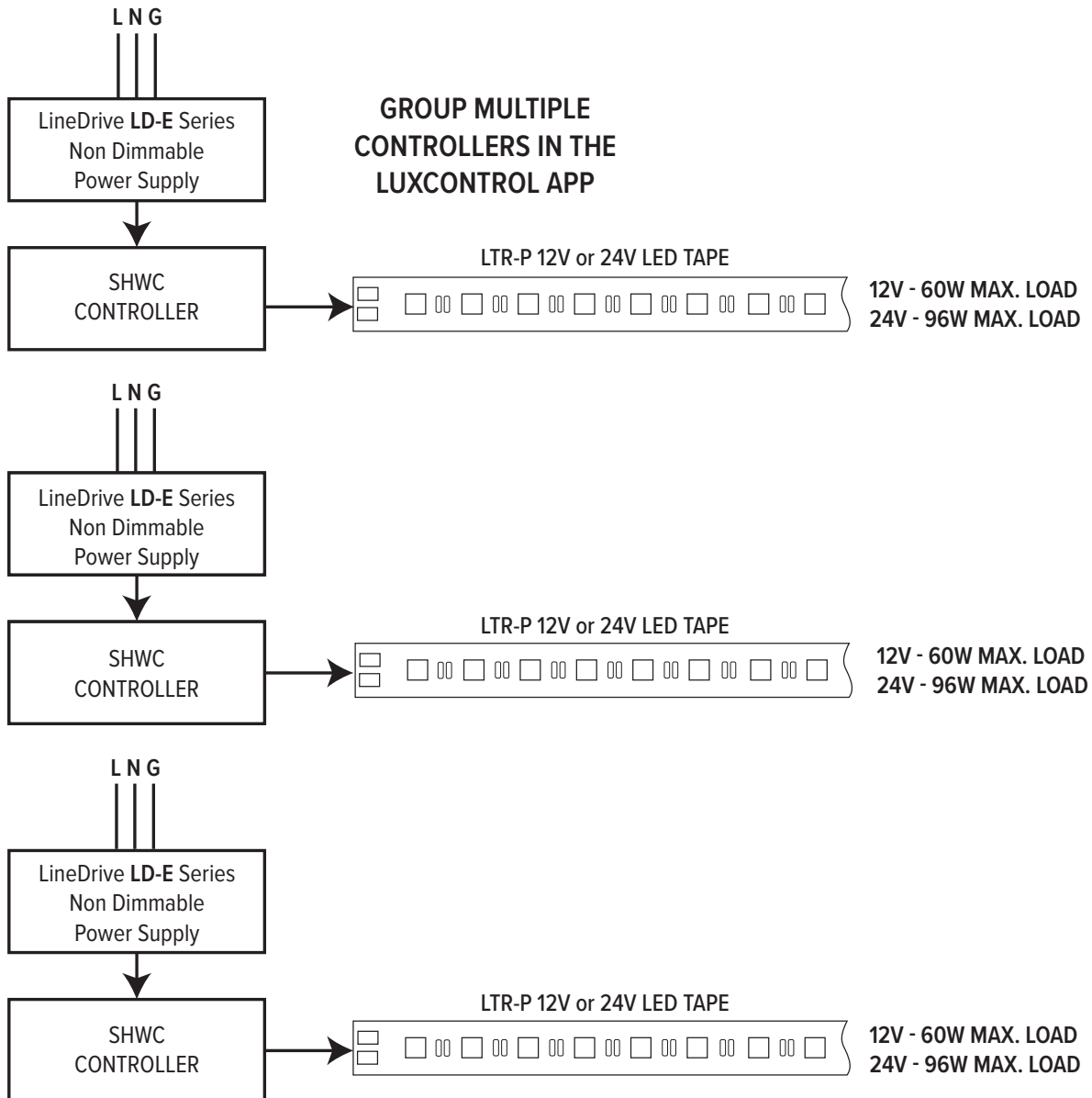

LTR-P Professional Series

4.5W, 24VDC LED Tape Specification Sheet



SHWC LUXCONTROL WIFI CONTROLLER WITH POWER REPEATER

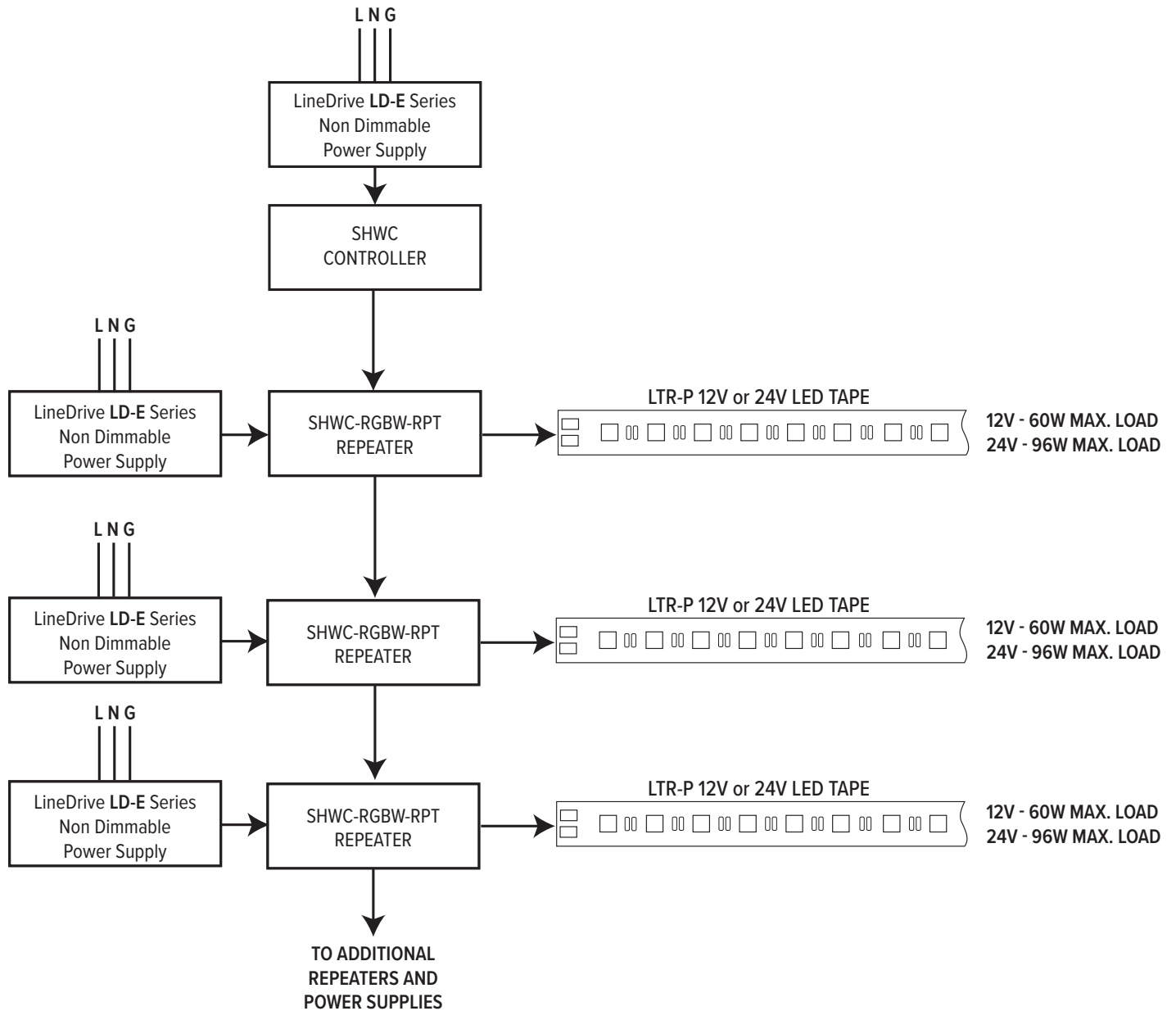

LTR-P Professional Series

4.5W, 24VDC LED Tape Specification Sheet



SHWD LUXCONTROL WIFI DIMMER

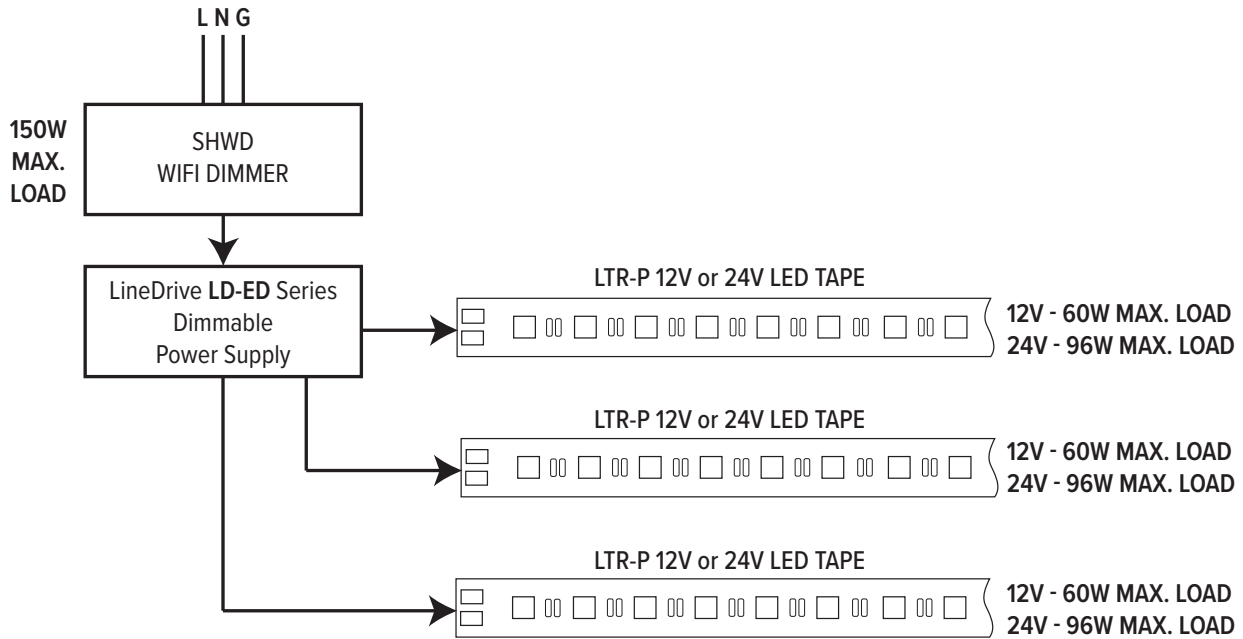

SWITCHLD SWD DRIVER AND DIMMER

SWITCHLD - SWD 12VDC or 24VDC - see pg. 2

