

NeoVision24 SideFlex

Flexible Neon LED Tape Specification Sheet

Project Name	Type
Catalog #	Date

PRODUCT OVERVIEW

A 24VDC high transmission, flexible linear 'neon' tape that is field cuttable and joinable. Designed for applications that require ultra-rich light and color saturation that is characteristic of neon. SideFlex enables horizontal bending that conforms tape around curvilinear surfaces.



FEATURES

- Multiple power feed options
- Tape encased in UV stable silicone (UV protected)
- Wireless control with LUXcontrol App and controller
- 2700K, 3000K, 4000K / Amber, Blue, Green or Red
- 120° viewing angle
- Maximum run: 32'-8"
- Cuttable and joinable in two inch increments
- Each run requires an end cap (sold separately)
- No tools required for capping and joining
- Mounting clips included (recommend use one per foot)

SPECIFICATIONS

ELECTRICAL

- 24VDC
- 3W per foot

PHOTOMETRIC

- 90+ CRI

AMBIENT OPERATING TEMP

- -13°F - 131°F

CERTIFICATION

- UL
- IP65

WARRANTY

- 5 years when paired with GM power supply

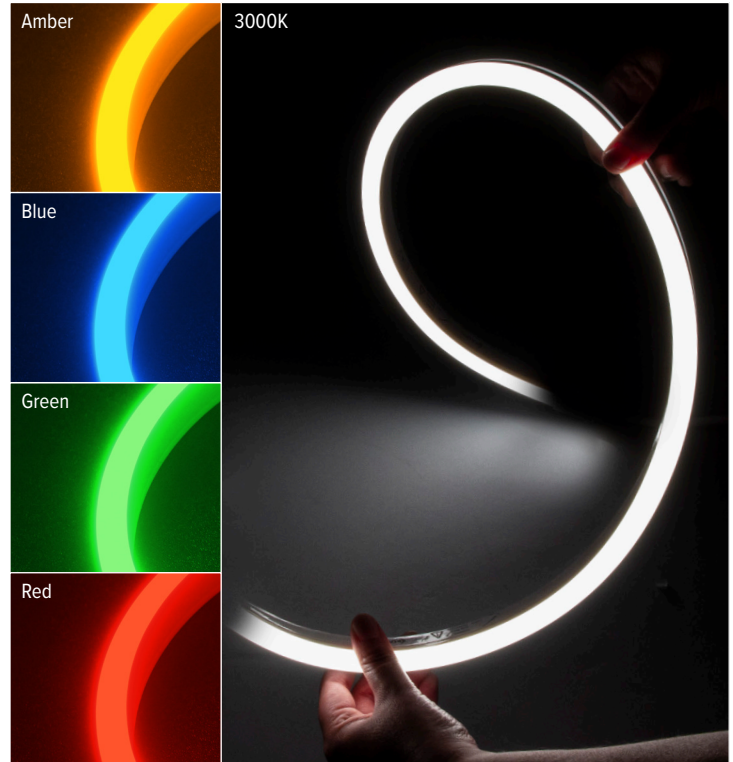

ORDERING INFORMATION

White

Product No.	Length	Lumens/ft	Color Temp
NV24S-3W-27K-16	16'-4"	215lm	2700K
NV24S-3W-27K-32	32'-8"	215lm	2700K
NV24S-3W-30K-16	16'-4"	230lm	3000K
NV24S-3W-30K-32	32'-8"	230lm	3000K
NV24S-3W-40K-16	16'-4"	215lm	4000K
NV24S-3W-40K-32	32'-8"	215lm	4000K

Colors

Product No.	Length	Lumens/ft	Color Temp
NV24S-3W-AM-16	16'-4"	N/A	Amber
NV24S-3W-AM-32	32'-8"	N/A	Amber
NV24S-3W-BL-16	16'-4"	N/A	Blue
NV24S-3W-BL-32	32'-8"	N/A	Blue
NV24S-3W-GR-16	16'-4"	N/A	Green
NV24S-3W-GR-32	32'-8"	N/A	Green
NV24S-3W-RD-16	16'-4"	N/A	Red
NV24S-3W-RD-32	32'-8"	N/A	Red

Max Run: 32'-8"

Kelvin temperature (color) ±100K.

NOTE: Every reel includes (1) NV24S-PF-EF (tape-to-power feed with 48" of lead). 16' reel includes (16) NV24S-MC-A mounting clips and screws. 32' reel comes with (32) NV24S-MC-A mounting clips and screws.

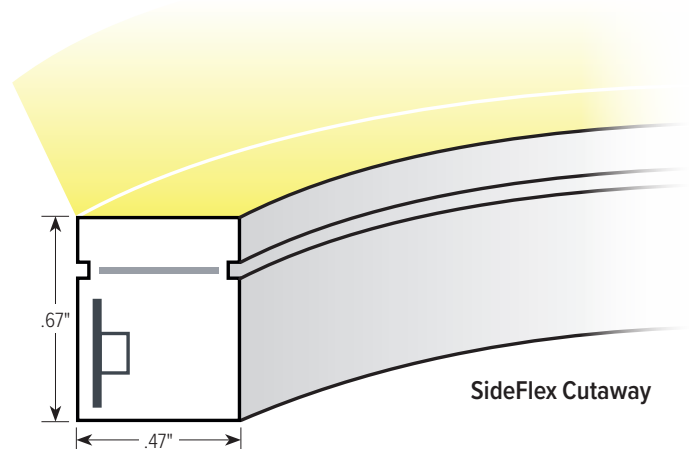

NeoVision24 SideFlex

Flexible Neon LED Tape Specification Sheet



CONNECTORS AND ACCESSORIES

Product No.	Description
NV24S-PF-EF8	Tape-to-Power Flexible End Feed, 8 ft.
NV24S-PF-BF8	Tape-to-Power Flexible Bottom Feed, 8 ft.
NV24S-SP	Tape-to-Tape Splice Connector
NV24S-CHL-A4	Aluminum Channel, 4 ft.
NV24S-CHL-A6	Aluminum Channel, 6 ft.
NV24S-MC-A	Aluminum Mounting Clips (set of 20)

Product No.	Description
NV24S-TTC6	Tape-to-Tape Flexible Connector, 6"
NV24S-TTC12	Tape-to-Tape Flexible Connector, 12"
NV24S-TTC24	Tape-to-Tape Flexible Connector, 24"
NV24S-FLEX-CHL	Flexible Mounting Channel, 39.5"
NV24S-EC	End Cap
NV24-CT	Tape Cutting Tool

The above connectors, channels, mounting clips and caps are for the exclusive use of NeoVision24 SideFlex Neon Tape and are ordered separately.

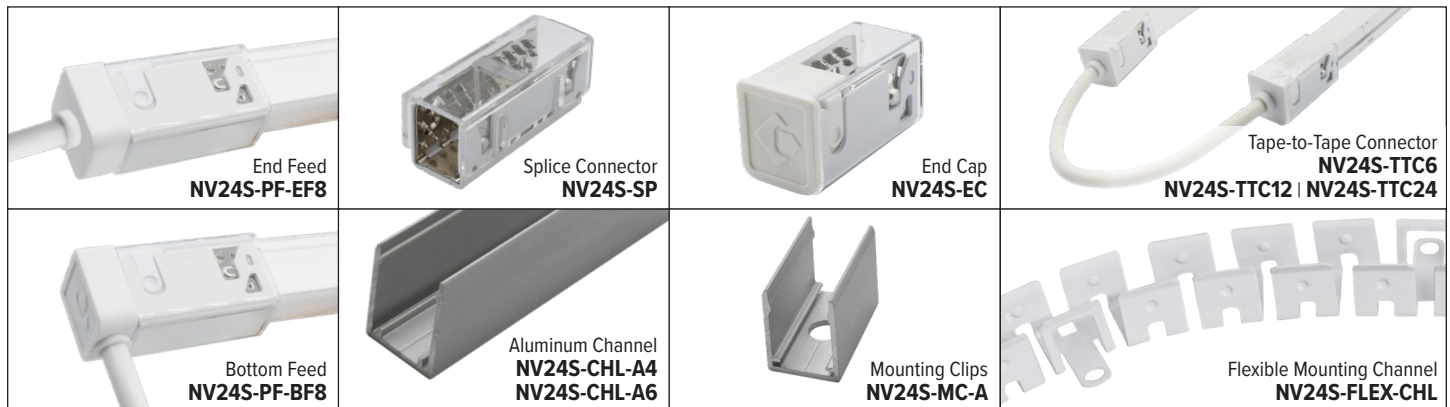

Tape Configuration Example

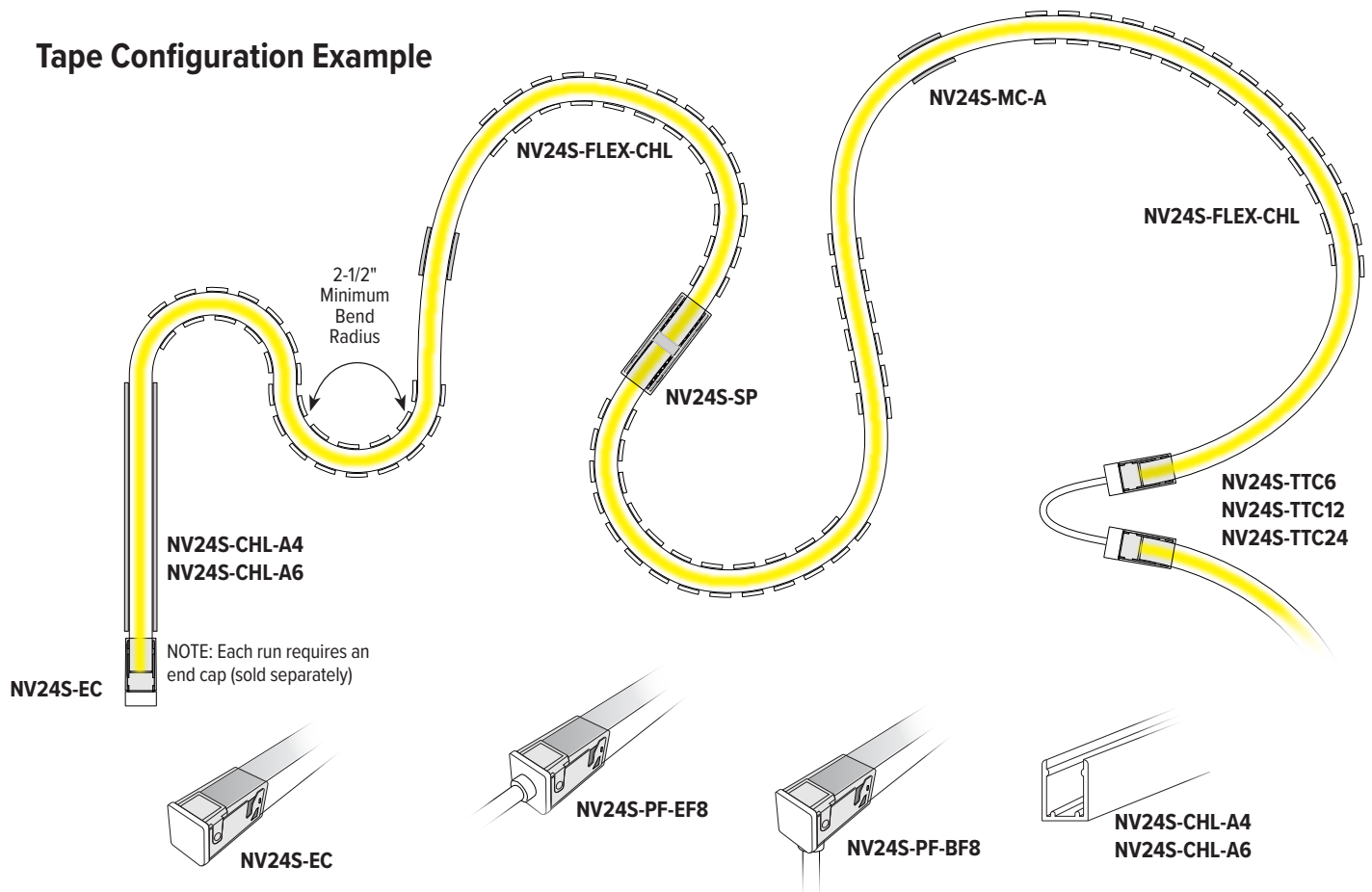

NeoVision24 SideFlex



Flexible Neon LED Tape Specification Sheet

DIMENSIONS

NV24S-PF-EF8

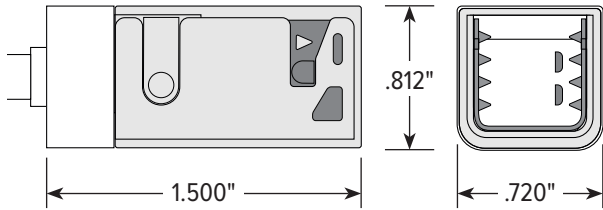

NV24S-PF-BF8

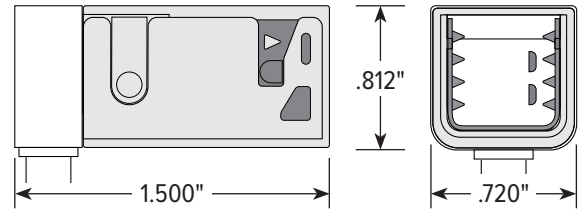

NV24S-SP

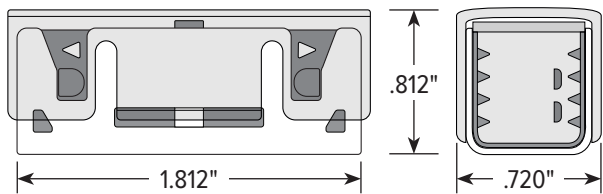

NV24S-EC

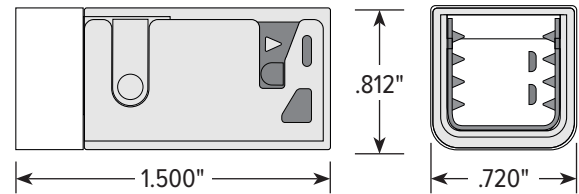

NV24S-CHL-A4 (4' L)
NV24S-CHL-A6 (6' L)

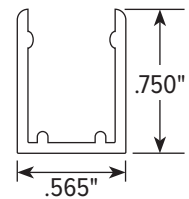

NV24S-MC-A

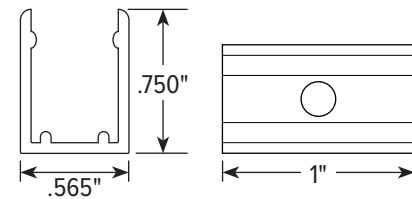

NV24S-FLEX-CHL

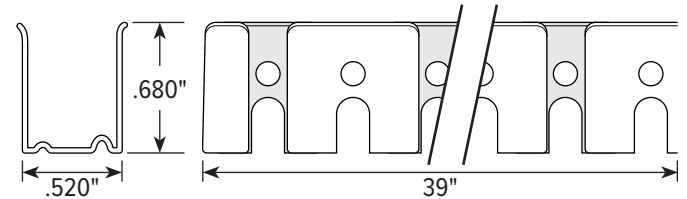

NV24S-TTC6 | NV24S-TTC12 | NV24S-TTC24

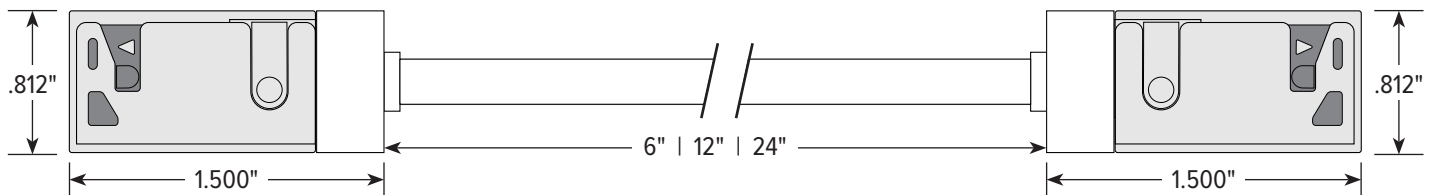

SideFlex Tape

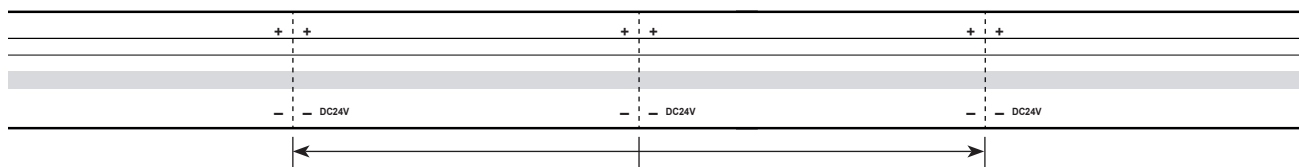

Cutable every 2"

NeoVision24 SideFlex

Flexible Neon LED Tape Specification Sheet



WIRING DIAGRAM

Single Color Smart Controller

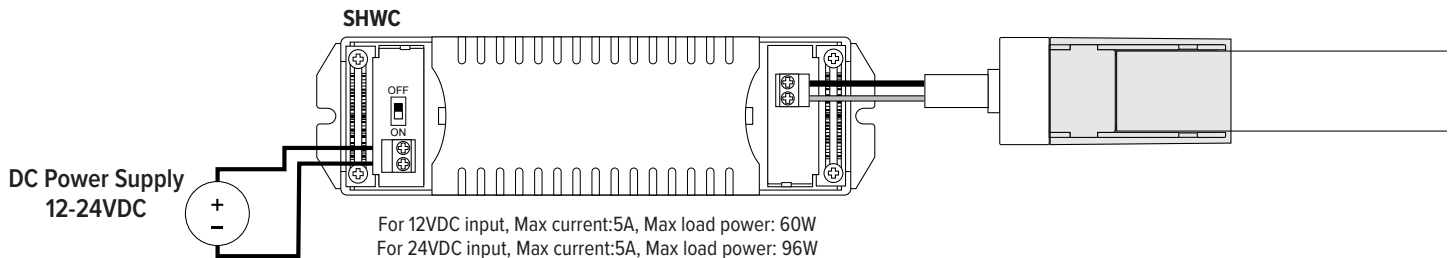

Repeater Wiring Single color connection - One channel

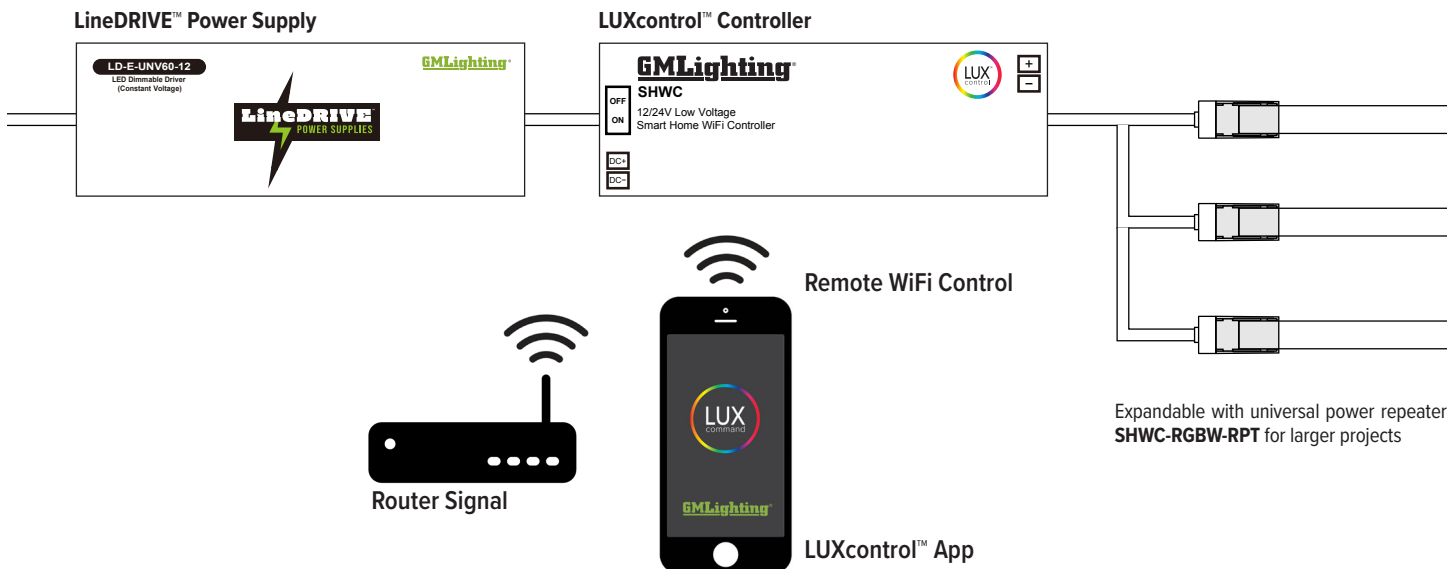
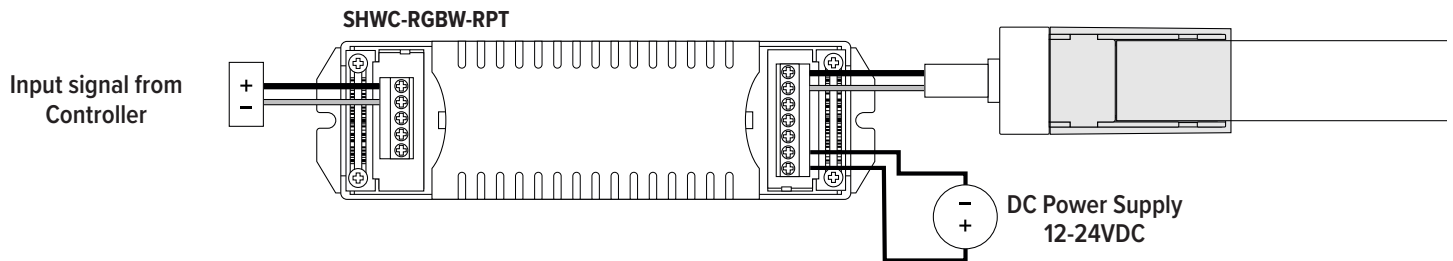

CONTROLLERS

Product No.	Description
SHWC*	Smart 2.4 GHz WiFi Controller, Standard 12V/24V Low Voltage, 1-Channel / 2-Wire
SHWC-RGBW-RPT*	Universal Smart Power Repeater

POWER SUPPLIES

Product No.	Description
LD-XD Series	LineDRIVE 24V Dimmable Power Supplies
LD-MD Series	LineDRIVE 24V Magnetic Power Supplies
PSD Series	Constant Voltage 24V Dimmable Power Supplies

*NOTE: For use with LD-E (non-dimmable) or LD-XD (dimmable) power supply only.
Not compatible with LD-MD (magnetic) power supply.

NeoVision24 SideFlex

Flexible Neon LED Tape Specification Sheet



SHWC LUXCONTROL WIFI CONTROLLER

**GROUP MULTIPLE
CONTROLLERS IN THE
LUXCONTROL APP**

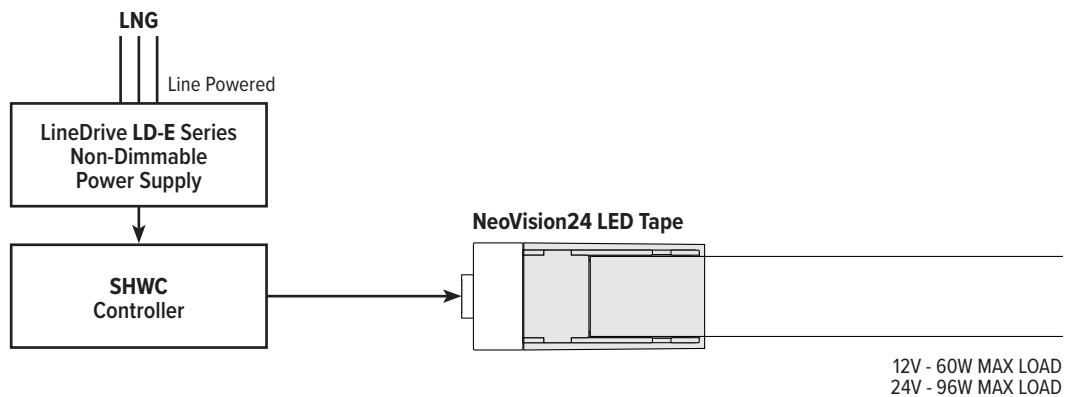
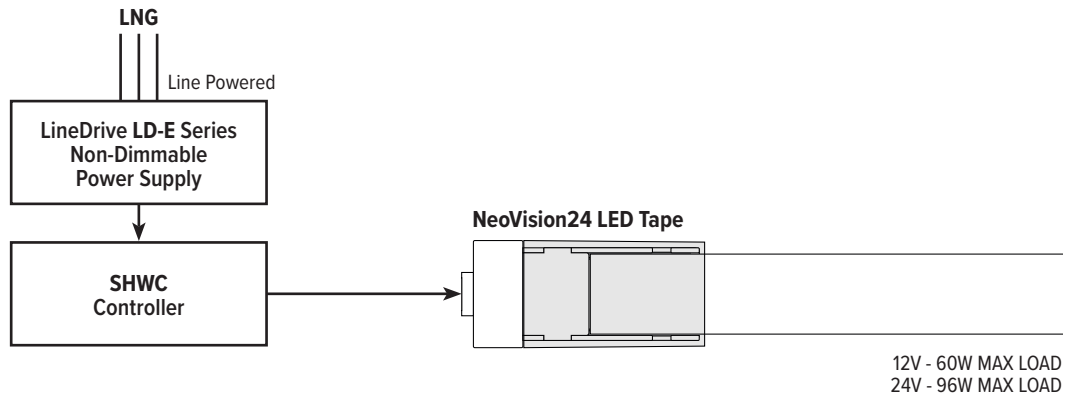
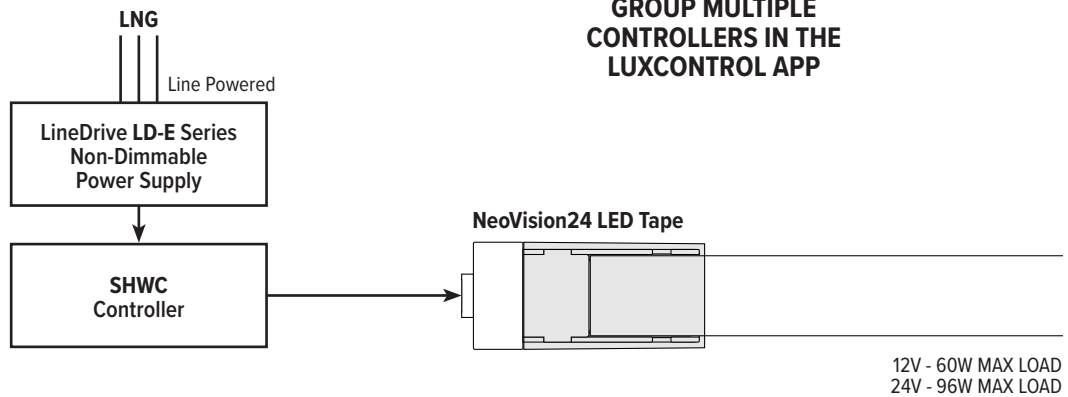

NeoVision24 SideFlex

Flexible Neon LED Tape Specification Sheet

SHWC LUXCONTROL WIFI CONTROLLER WITH POWER REPEATER

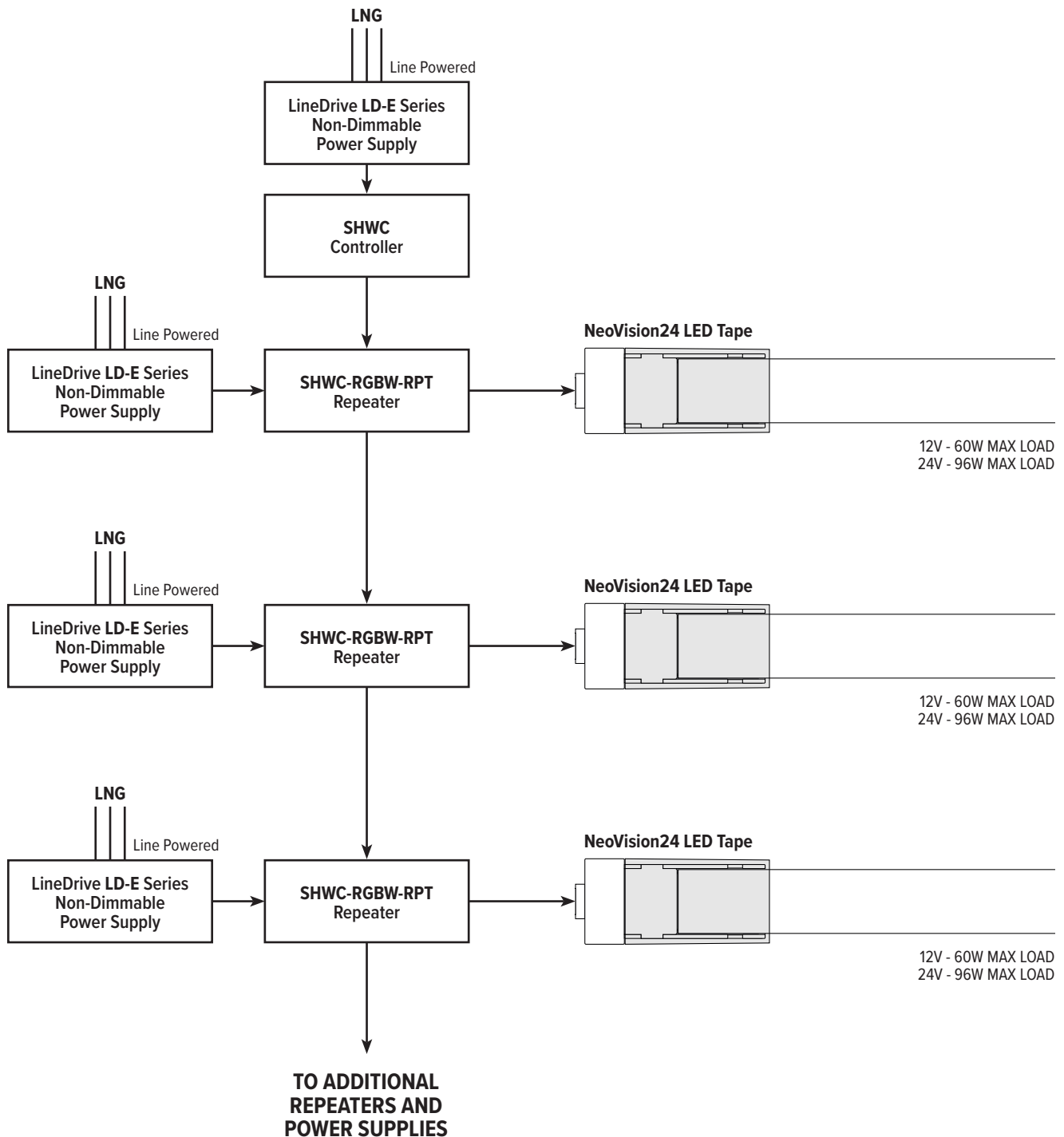

NeoVision24 SideFlex

Flexible Neon LED Tape Specification Sheet

SHWD LUXCONTROL WIFI CONTROLLER

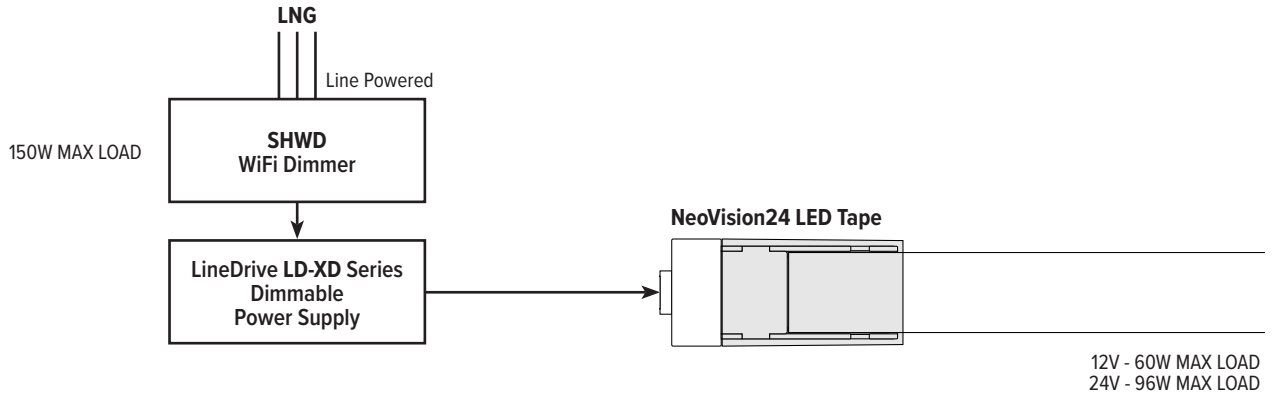

SHWD SWD DRIVER AND DIMMER

SWITCHLD - SWD
12VDC or 24VDC
12V - 48W MAX LOAD
24V - 80W MAX LOAD

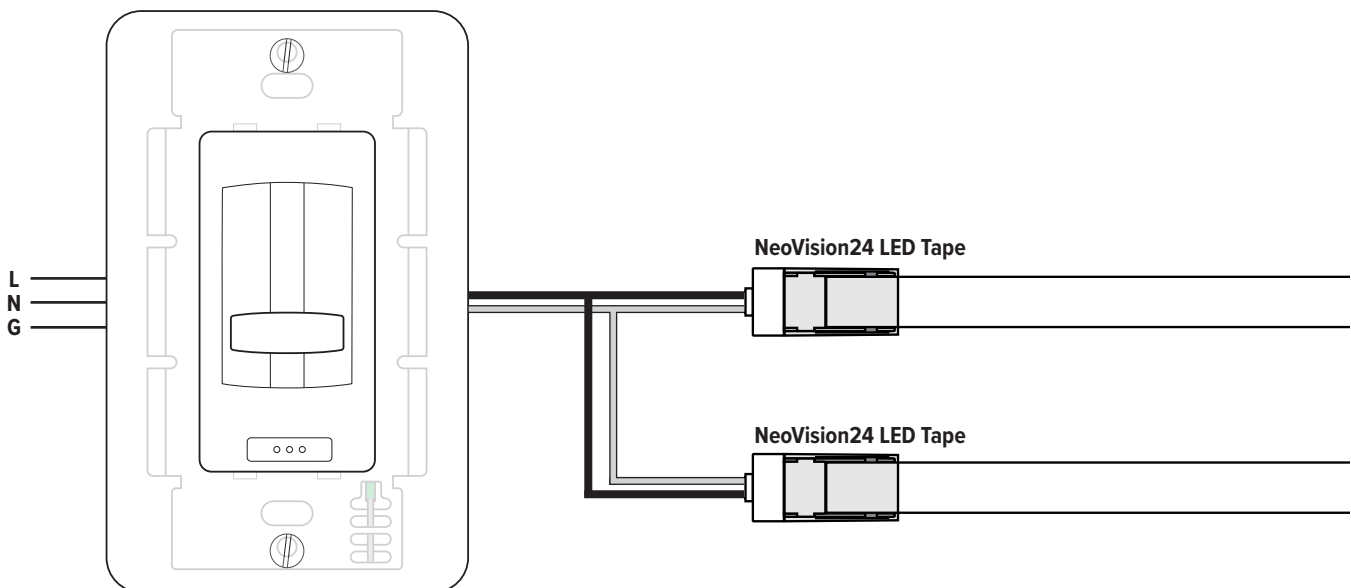

NeoVision24 SideFlex



Flexible Neon LED Tape Specification Sheet

RF CONTROLLER

Incoming power for (L N G) options can be 120V or 277V.
 Check power supply for proper input voltage and output power required.
 Power Supply output voltage must match LED operating voltage. (24VDC)
 Power supply used **MUST NOT BE DIMMED** at the input to properly power the controls.
 See Controller instructions for pairing and wiring details.

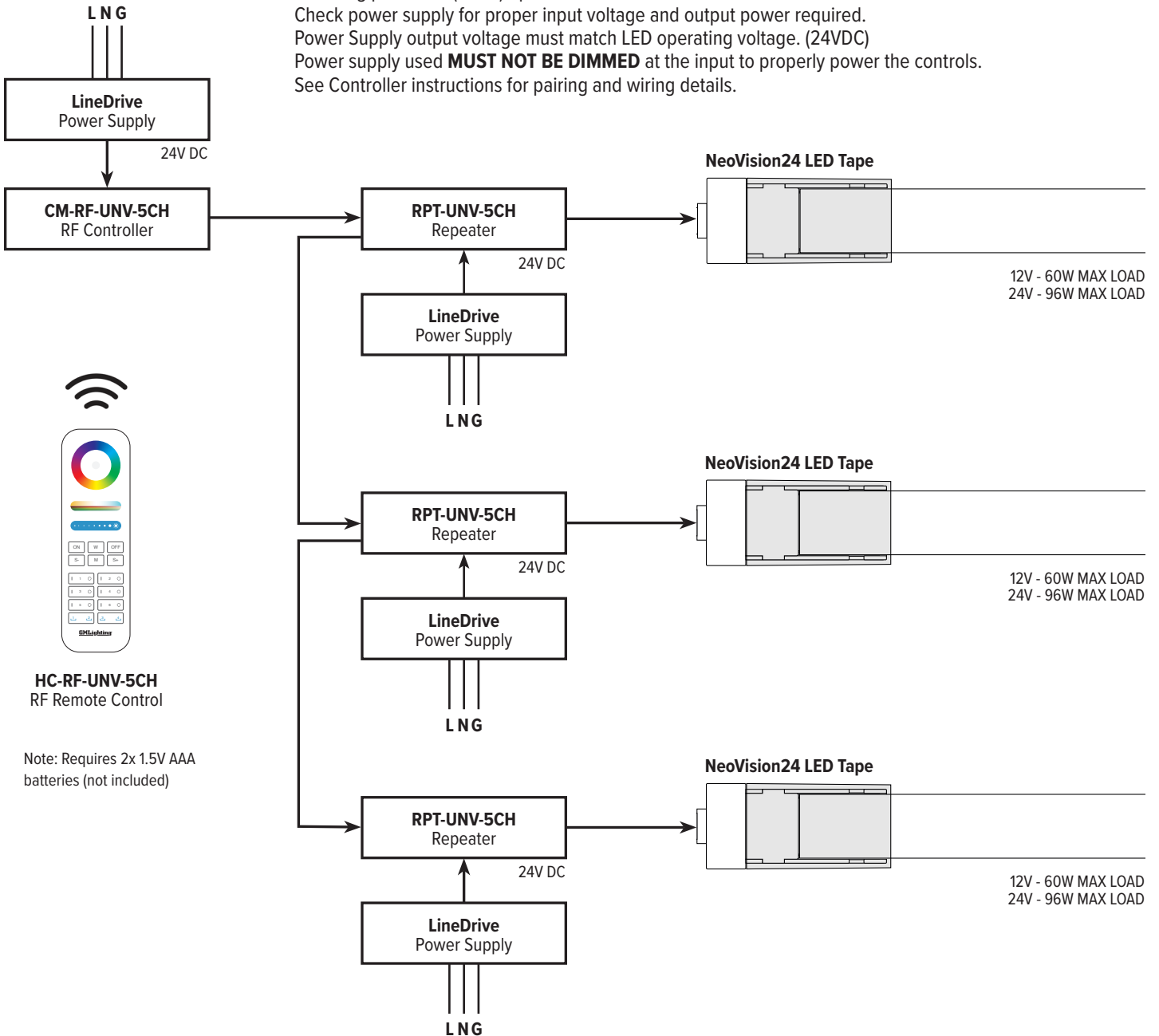

CONTROLLERS

Product No.	Description
HC-RF-UNV-5CH	Universal 1-5 Channel RF Remote Control
CM-RF-UNV-5CH	Universal 1-5 Channel Control Module
RPT-UNV-5CH	Universal 1-5 Channel Repeater Amplifier

Note: Multiple power supplies can be replaced with a single multi-output power supply.

POWER SUPPLIES

Product No.	Description
LD-E-UNV Series	LineDRIVE 12V / 24V Non-Dimmable Power Supplies
LD-XD-UNV Series	LineDRIVE 12V / 24V Power Supplies
LTP Series	24V Electronic LED Power Supplies

NeoVision24 SideFlex

Flexible Neon LED Tape Specification Sheet



RF HAND HELD REMOTE FEATURES AND DIMENSIONS

RF Remote Control
HC-RF-UNV-5CH
with Built-In Effects

