

NeoVision24 TopFlex

Flexible Neon LED Tape Specification Sheet

Project Name	Type
Catalog #	Date

PRODUCT OVERVIEW

A 24VDC high transmission, flexible linear 'neon' tape that is field cuttable and joinable. Designed for applications that require ultra-rich light and color saturation that is characteristic of neon. TopFlex enables vertical bending that conforms tape around curvilinear surfaces.



FEATURES

- Multiple power feed options
- Tape encased in UV stable silicone (UV protected)
- Wireless control with LUXcontrol App and controller
- 2700K, 3000K, 4000K / Amber, Blue, Green or Red
- 120° viewing angle
- Maximum run: 32'-8"
- Cuttable and joinable in two inch increments
- Each run requires an end cap (sold separately)
- No tools required for capping and joining
- Mounting clips included (recommend use one per foot)

SPECIFICATIONS

ELECTRICAL

- 24VDC
- 3W per foot

PHOTOMETRIC

- 90+ CRI

AMBIENT OPERATING TEMP

- -13°F - 131°F

CERTIFICATION

- UL
- IP65

WARRANTY

- 5 years when paired with GM power supply



ORDERING INFORMATION

White

Product No.	Length	Lumens/ft	Color Temp
NV24T-3W-27K-16	16'-4"	215lm	2700K
NV24T-3W-27K-32	32'-8"	215lm	2700K
NV24T-3W-30K-16	16'-4"	230lm	3000K
NV24T-3W-30K-32	32'-8"	230lm	3000K
NV24T-3W-40K-16	16'-4"	215lm	4000K
NV24T-3W-40K-32	32'-8"	215lm	4000K

Colors

Product No.	Length	Lumens/ft	Color Temp
NV24T-3W-AM-16	16'-4"	N/A	Amber
NV24T-3W-AM-32	32'-8"	N/A	Amber
NV24T-3W-BL-16	16'-4"	N/A	Blue
NV24T-3W-BL-32	32'-8"	N/A	Blue
NV24T-3W-GR-16	16'-4"	N/A	Green
NV24T-3W-GR-32	32'-8"	N/A	Green
NV24T-3W-RD-16	16'-4"	N/A	Red
NV24T-3W-RD-32	32'-8"	N/A	Red

Max Run: 32'-8"

Kelvin temperature (color) ±100K.

NOTE: Every reel includes (1) **NV24T-PF-EF** (tape-to-power feed with 48" of lead). 16' reel includes (16) **NV24T-MC-A** mounting clips and screws. 32' reel comes with (32) **NV24T-MC-A** mounting clips and screws.

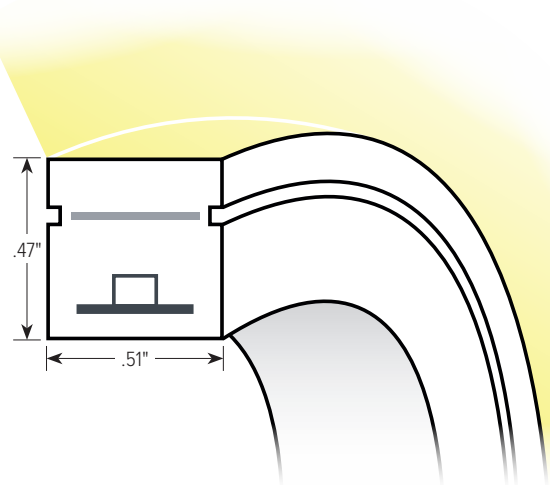

TopFlex Cutaway

NeoVision24 TopFlex

Flexible Neon LED Tape Specification Sheet



CONNECTORS AND ACCESSORIES

Product No.	Description
NV24T-PF-EF8	Tape-to-Power Flexible End Feed, 8 ft.
NV24T-PF-BF8	Tape-to-Power Flexible Bottom Feed, 8 ft.
NV24T-SP	Tape-to-Tape Splice Connector
NV24T-CHL-A4	Aluminum Channel, 4 ft.
NV24T-CHL-A8	Aluminum Channel, 8 ft.
NV24T-MC-A	Aluminum Mounting Clips (set of 20)

Product No.	Description
NV24T-TTC6	Tape-to-Tape Flexible Connector, 6"
NV24T-TTC12	Tape-to-Tape Flexible Connector, 12"
NV24T-TTC24	Tape-to-Tape Flexible Connector, 24"
NV24T-FLEX-CHL	Flexible Mounting Channel, 39.5"
NV24T-EC	End Cap
NV24-CT	Tape Cutting Tool

The above connectors, channels, mounting clips and caps are for the exclusive use of **NeoVision24 TopFlex Neon Tape** and are ordered separately.

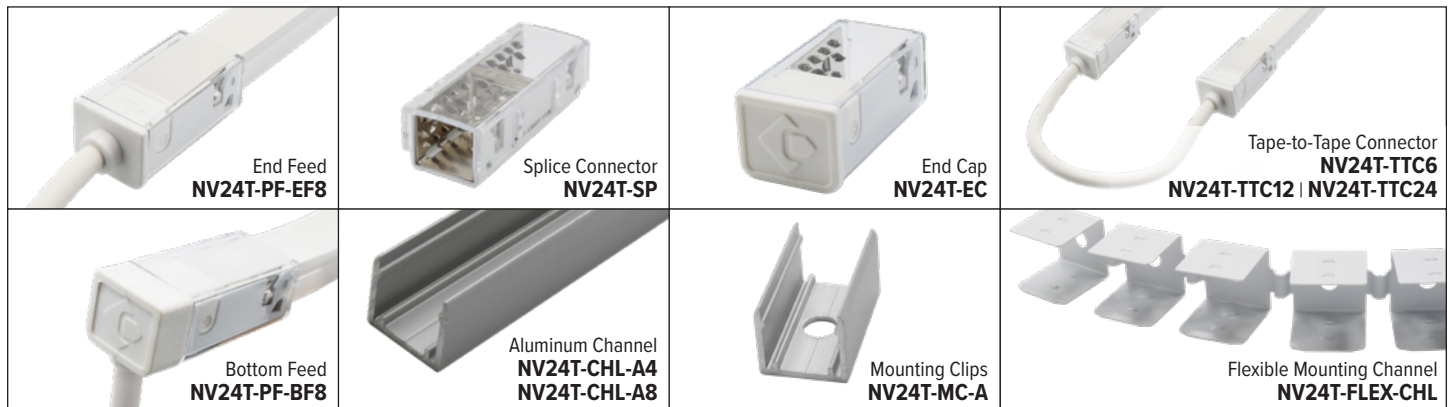

Tape Configuration Example

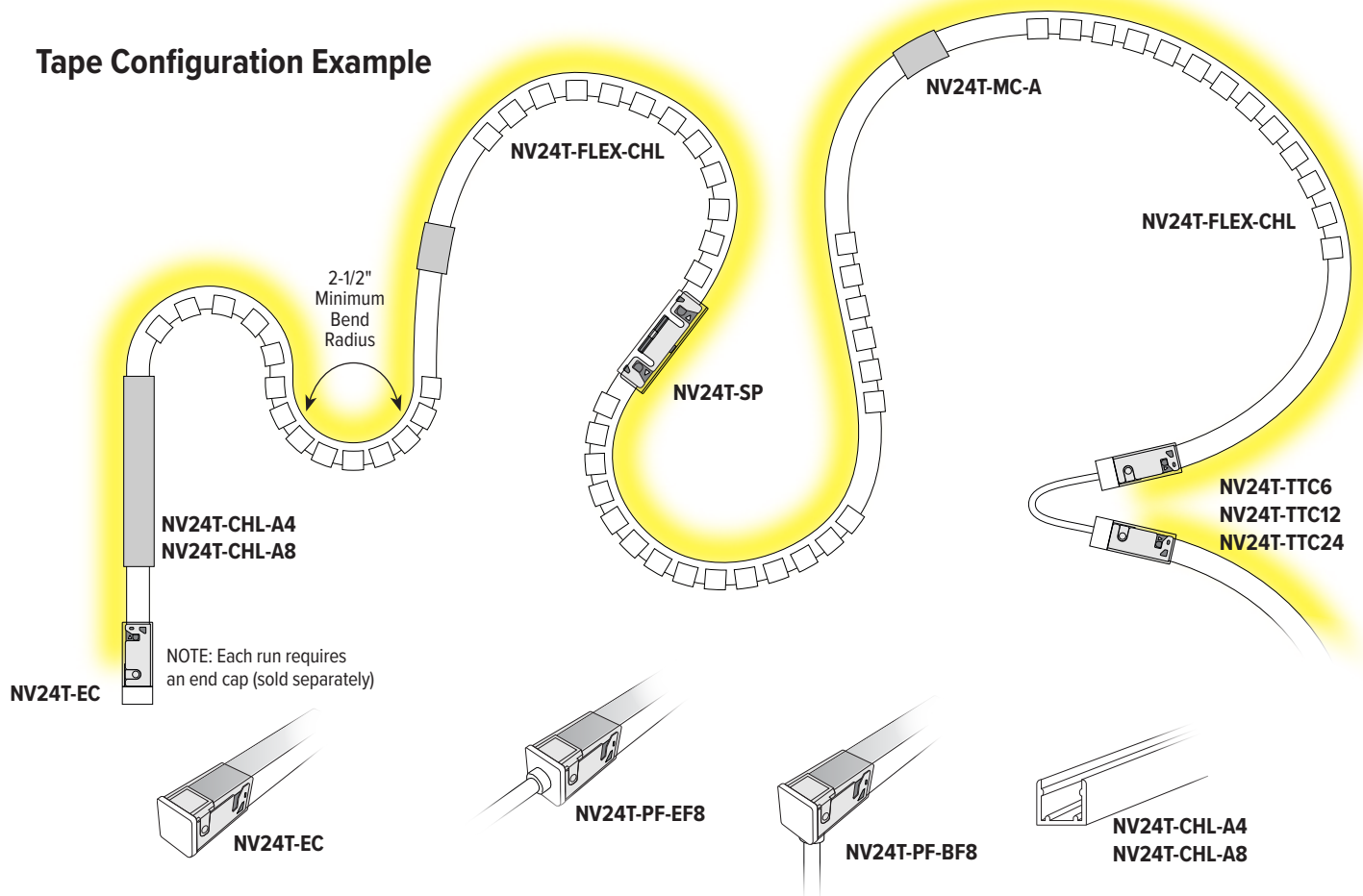

NeoVision24 TopFlex

Flexible Neon LED Tape Specification Sheet



DIMENSIONS

NV24T-PF-EF8

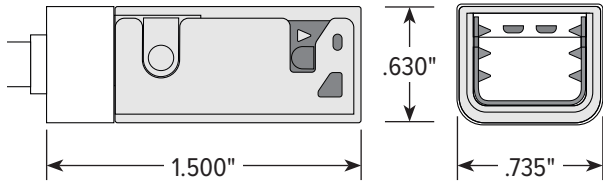

NV24T-PF-BF8

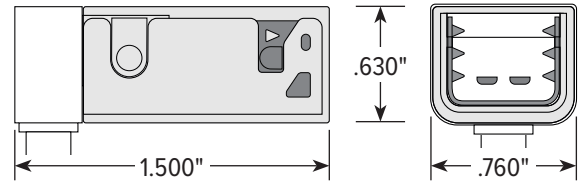

NV24T-SP

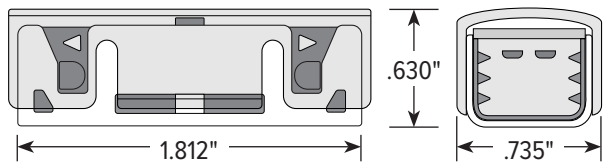

NV24T-EC

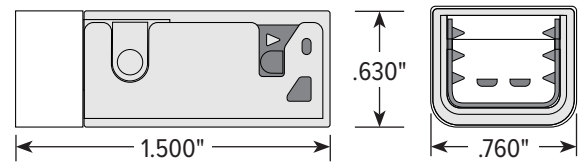

NV24T-CHL-A4 (4' L)
NV24T-CHL-A8 (8' L)

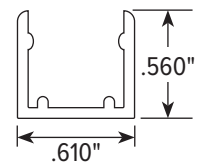

NV24T-MC-A

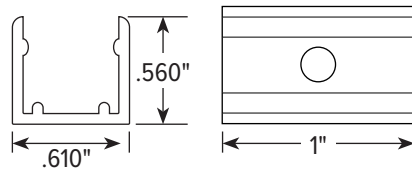

NV24T-FLEX-CHL

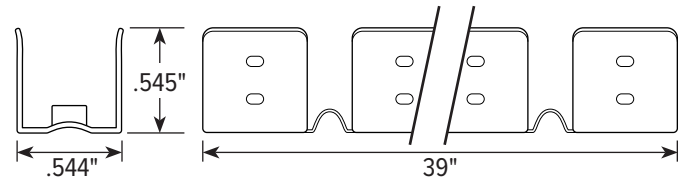

NV24S-TTC6 | NV24S-TTC12 | NV24S-TTC24

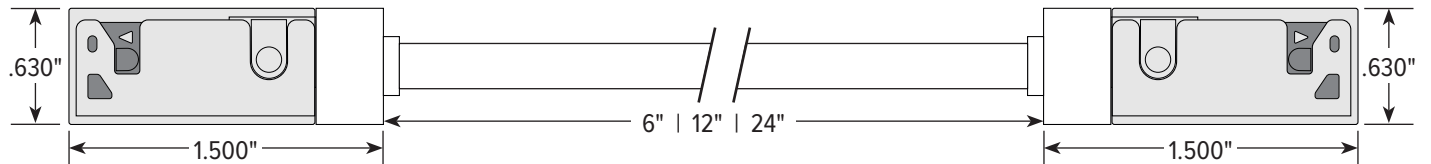

TopFlex Tape

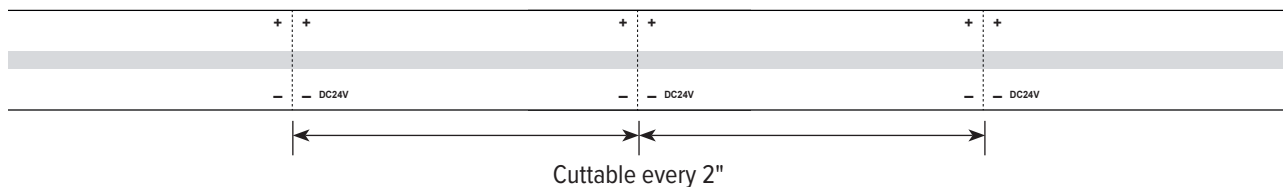

NeoVision24 TopFlex

Flexible Neon LED Tape Specification Sheet



WIRING DIAGRAM

Single Color Smart Controller

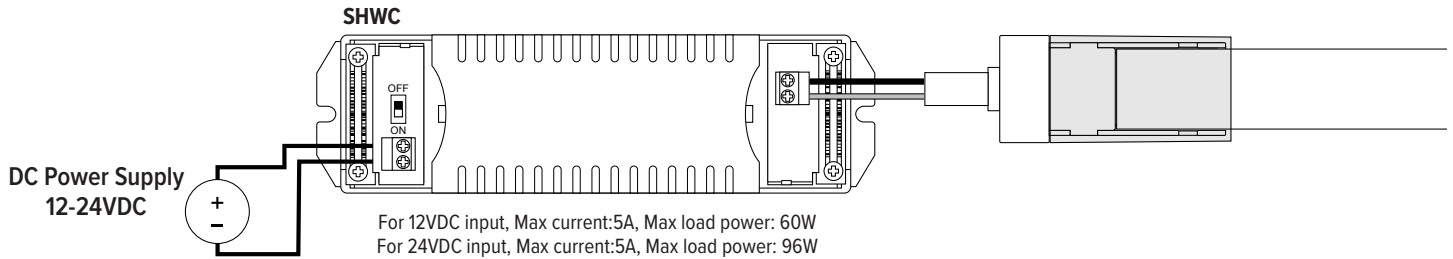

Repeater Wiring Single color connection - One channel

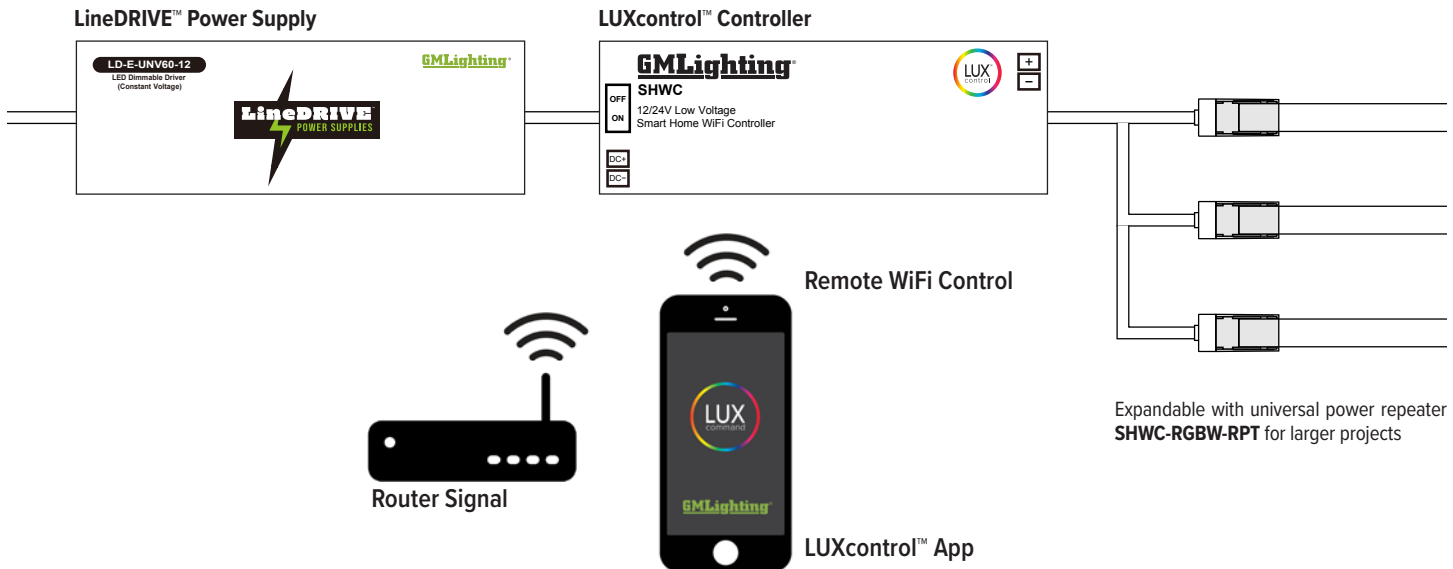
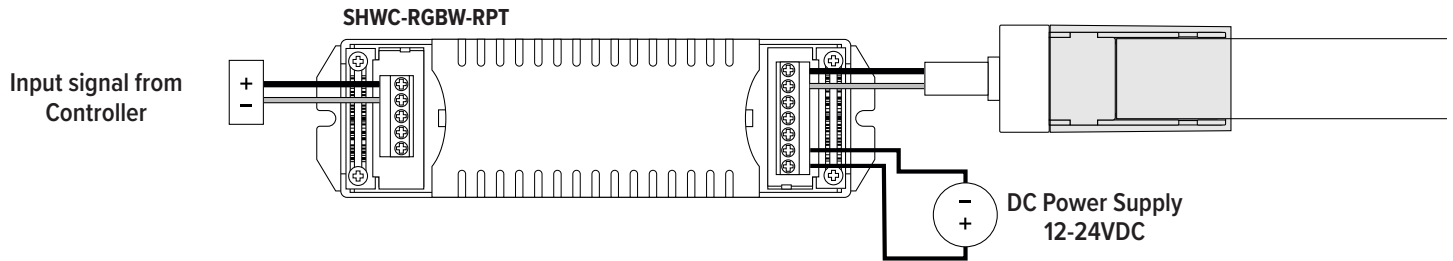

CONTROLLERS

Product No.	Description
SHWC*	Smart 2.4 GHz WiFi Controller, Standard 12V/24V Low Voltage, 1-Channel / 2-Wire
SHWC-RGBW-RPT*	Universal Smart Power Repeater

POWER SUPPLIES

Product No.	Description
LD-XD Series	LineDRIVE 24V Dimmable Power Supplies
LD-MD Series	LineDRIVE 24V Magnetic Power Supplies
PSD Series	Constant Voltage 24V Dimmable Power Supplies

*NOTE: For use with LD-E (non-dimmable) or LD-XD (dimmable) power supply only.
Not compatible with LD-MD (magnetic) power supply.

NeoVision24 TopFlex

Flexible Neon LED Tape Specification Sheet



SHWC LUXCONTROL WIFI CONTROLLER

**GROUP MULTIPLE
CONTROLLERS IN THE
LUXCONTROL APP**

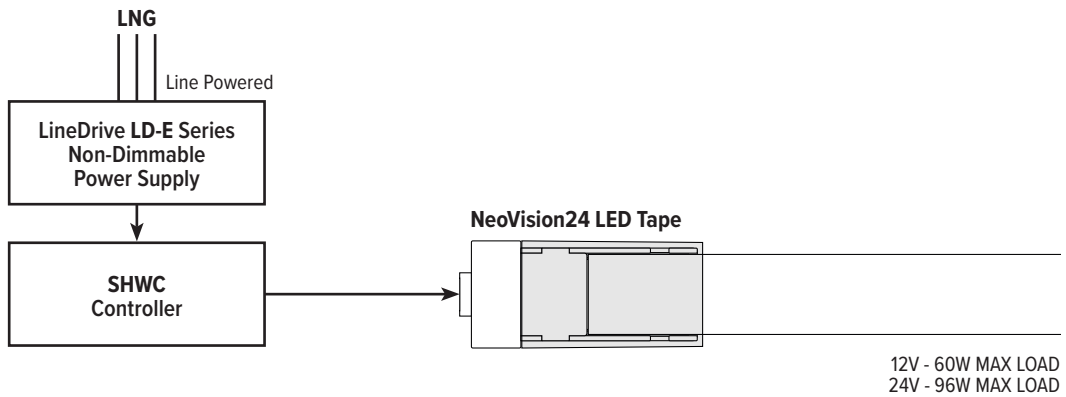
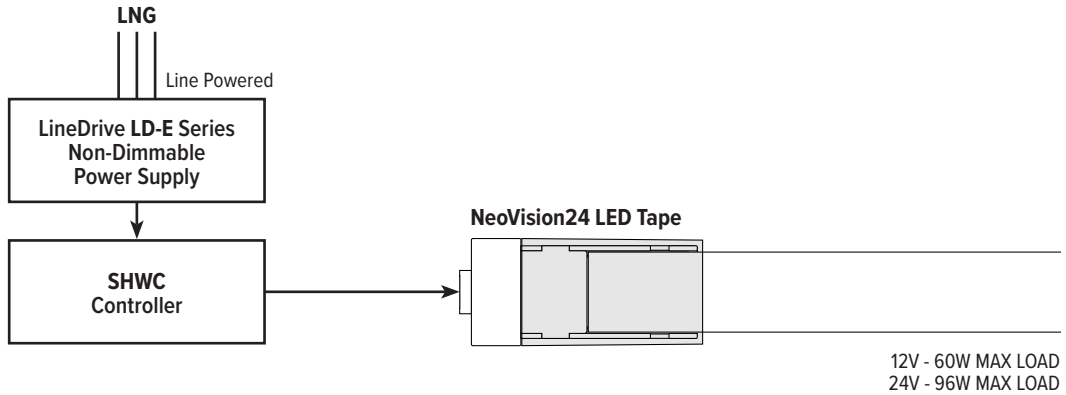
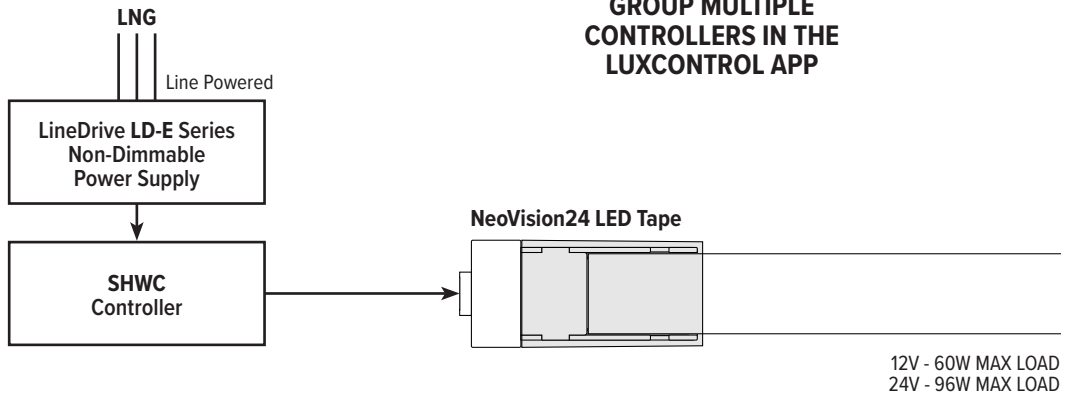

NeoVision24 TopFlex

Flexible Neon LED Tape Specification Sheet



SHWC LUXCONTROL WIFI CONTROLLER WITH POWER REPEATER

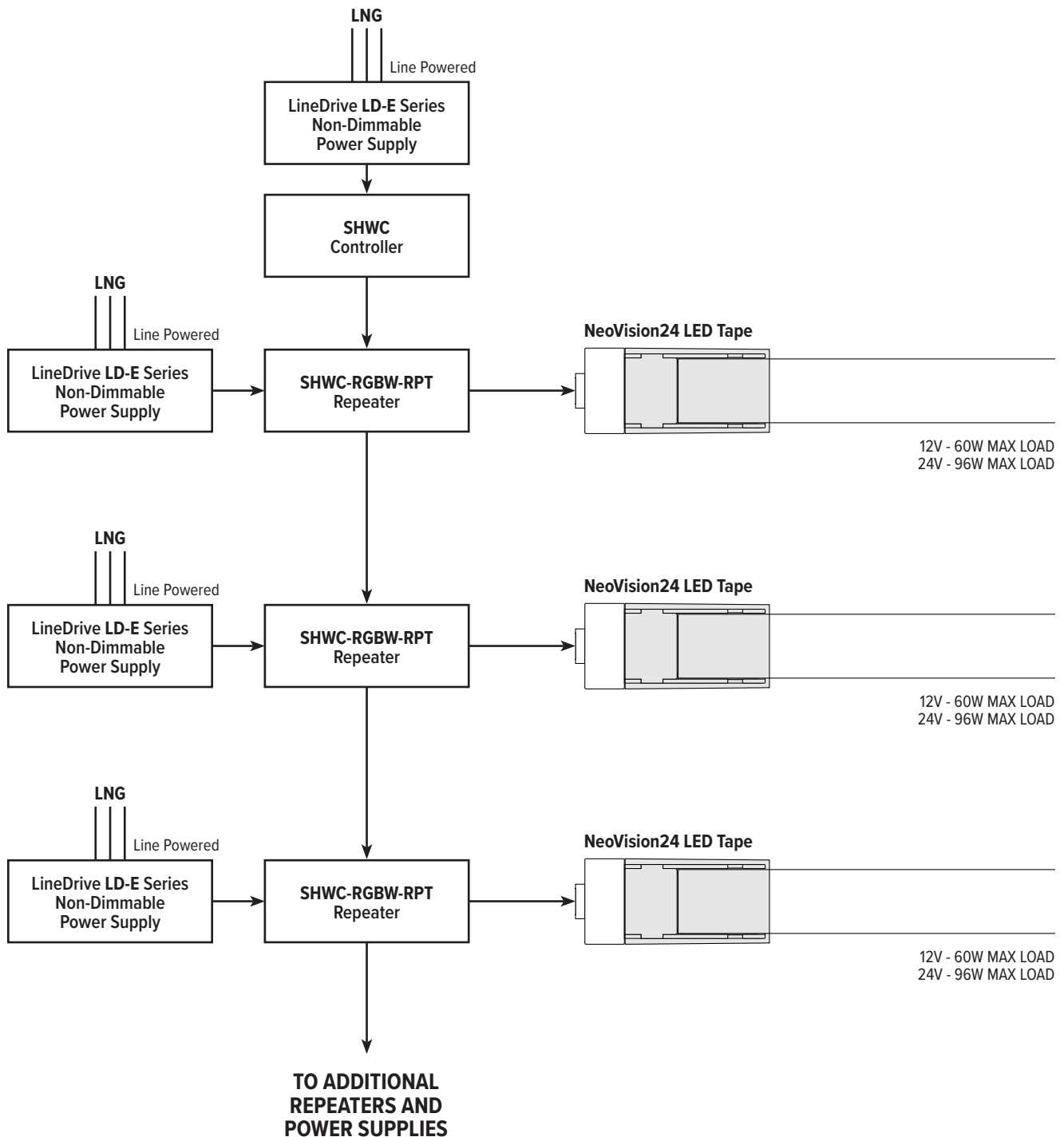

NeoVision24 TopFlex

Flexible Neon LED Tape Specification Sheet

SHWD LUXCONTROL WIFI CONTROLLER

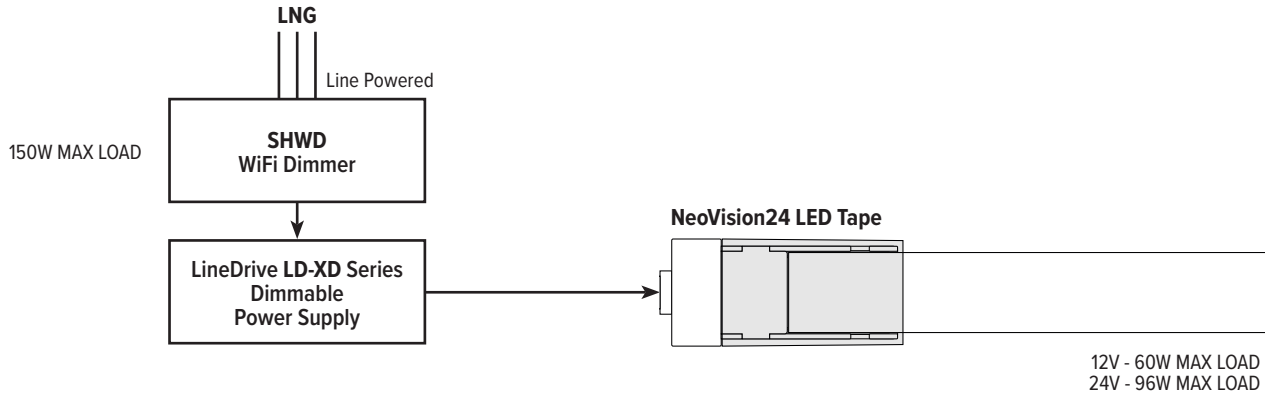

SHWD SWD DRIVER AND DIMMER

SWITCHLD - SWD
12VDC or 24VDC
12V - 48W MAX LOAD
24V - 80W MAX LOAD

