

MicroTask 4

5CCT 120V Mini IC Rated High Lumen Regressed Specification Sheet

Project Name	Type
Catalog #	Date

PRODUCT OVERVIEW

This MicroTask 4 “HL” offers a high lumen output in a very versatile mid-sized, downlight. Excellent color rendition with a smooth, 38° or 60° beam spread puts the best light into your application. Select a housing and 1 of 8 trim styles and colors to configure a winning combination. A power supply with integrated junction box simplifies installation.

FEATURES

- Solid construction with aluminum housing and trim
- Acrylic lens for clarity and high efficiency
- 5CCT selectable for various applications
- Snap-in spring clips installation
- IC rated for airtight installations
- LUXcontrol App compatible when installed with SHWD
- Title 24, Energy Star qualifies for efficient and flicker free operation
- High lumens for larger spaces

SPECIFICATIONS

ELECTRICAL

- 120VAC 60Hz
- 18W

PHOTOMETRICS

- 90+ CRI, R9>50
- 38° or 60° beam angles
- 5CCT selectable:
2700K, 3000K,
3500K, 4000K, 5000K

CERTIFICATIONS

- ETL (US and Canada)
- Title 24 - JA8
- Energy Star
- Wet location, indoor covered location

WARRANTY

- 5 years



38° Beam

MDL-4HFL-HL-5CCT



60° Beam

MDL-4HWFL-HL-5CCT

ORDERING INFORMATION

To build fixture:

1. Select housing
2. Select trim

Assemble on site

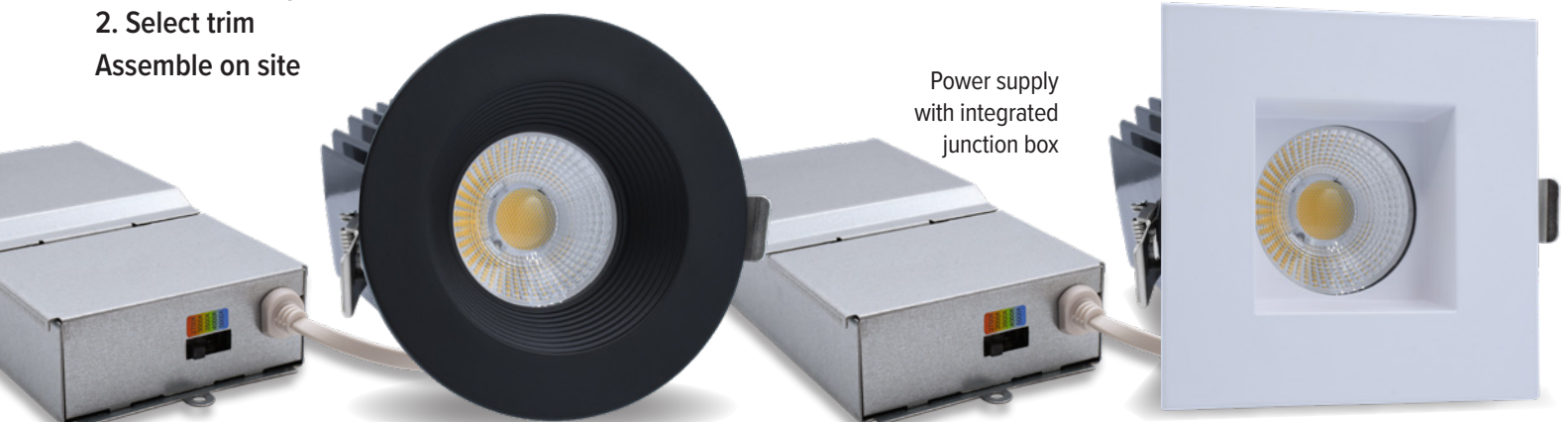

MicroTask 4

5CCT 120V Mini IC Rated High Lumen Regressed Specification Sheet

ORDERING INFORMATION

1. Select Housing

Example: **MDL-4HFL-HL-5CCT**

Model	-	Size/Spread	-	Hi Lumen	-	Color Temp
MDL		4HFL 4HWFL		HL		5CCT Selectable: 2700K/3000K/3500K/4000K/5000K

Catalog No.	Beam Spread	Dimensions	Wattage	Lumens in 3000K	Color Temp	CRI	Finish
MDL-4HFL-HL-5CCT	38°	4-1/2" dia x 5" depth	18W	1371lm	5CCT selectable:	90+	Black
MDL-4HWFL-HL-5CCT	60°	4-1/2" dia x 5" depth	18W	1329lm	2700K/3000K/3500K/4000K/5000K	90+	Black

2. Select Trim

Catalog No.	Trim Shape/Type	Trim Dimensions
MDL-4R-TRSM-BK (Black)	MDL-4R-TRSM-WH (White)	Round Smooth
MDL-4R-TRST-BK (Black)	MDL-4R-TRST-WH (White)	Round Stepped
MDL-4S-TRSM-BK (Black)	MDL-4S-TRSM-WH (White)	Square Smooth
MDL-4S-TRST-BK (Black)	MDL-4S-TRST-WH (White)	Square Stepped

SMOOTH TRIMS



MDL-4R-TRSM-BK



MDL-4S-TRSM-BK

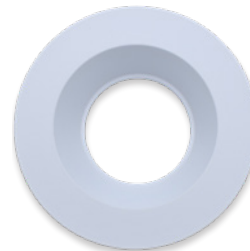

MDL-4R-TRSM-WH

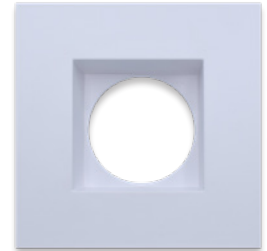

MDL-4S-TRSM-WH

STEPPED TRIMS



MDL-4R-TRST-BK



MDL-4S-TRST-BK

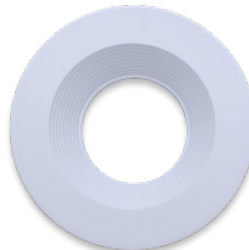

MDL-4R-TRST-WH

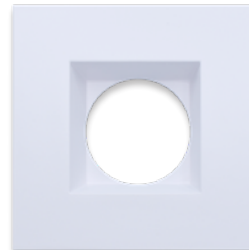

MDL-4S-TRST-WH

CONNECTORS AND ACCESSORIES

Catalog No.	Description
RSD-TUN-5FT-EXT	5' extension cord for MDL tunable downlights
RSD-TUN-10FT-EXT	10' extension cord for MDL tunable downlights
RSD-TUN-20FT-EXT	20' extension cord for MDL tunable downlights
UNV-NCP	New construction plate for all MDL series downlights

CUT-OUT DIMENSIONS

Catalog No.	Size	Clearance Depth
MDL-4R-TRSM / MDL-4S-TRSM	3-3/4" dia	5" min (for housing)
MDL-4R-TRST / MDL-4S-TRST	3-3/4" dia	5" min (for housing)

NOTE: Power supplies and electrical whip may require 10" clearance depth for insertion through hole.

MicroTask 4

5CCT 120V Mini IC Rated High Lumen Regressed Specification Sheet

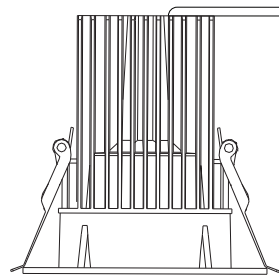

38° Beam

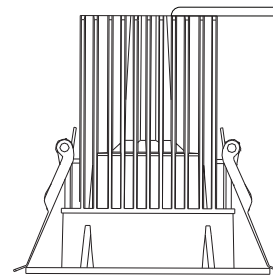

60° Beam

LUMEN TABLE

Model	Beam Spread	Lumen Levels	2700K	3000K	3500K	4000K	5000K
MDL-4HFL-HL-5CCT (+ 1 trim)	38°	Lumens	1211	1260	1363	1434	1445
MDL-4R-TRSM-BK							
MDL-4S-TRSM-BK		Lumen Factor	0.96	1.00	1.08	1.14	1.15
MDL-4R-TRST-BK							
MDL-4S-TRST-BK							
MDL-4HFL-HL-5CCT (+ 1 trim)	38°	Lumens	1305	1371	1430	1495	1490
MDL-4R-TRSM-WH							
MDL-4S-TRSM-WH		Lumen Factor	0.95	1.00	1.04	1.09	1.09
MDL-4R-TRST-WH							
MDL-4S-TRST-WH							

Model	Beam Spread	Lumen Levels	2700K	3000K	3500K	4000K	5000K
MDL-4HWFL-HL-5CCT (+ 1 trim)	60°	Lumens	1226	1282	1390	1410	1423
MDL-4R-TRSM-BK							
MDL-4S-TRSM-BK		Lumen Factor	0.96	1.00	1.08	1.10	1.11
MDL-4R-TRST-BK							
MDL-4S-TRSM-BK							
MDL-4HWFL-HL-5CCT (+ 1 trim)	60°	Lumens	1280	1329	1486	1550	1550
MDL-4R-TRSM-WH							
MDL-4S-TRSM-WH		Lumen Factor	0.96	1.00	1.12	1.17	1.17
MDL-4R-TRST-WH							
MDL-4S-TRST-WH							

NOTE: When using 3000K ies files, use Lumen Factor to get Lumen values for other Color Temperatures (CCT).

Example: MDL-4HFL-HL-5CCT-WH, 1371lm x 1.09 = 1495m at 4000K

MicroTask 4

5CCT 120V Mini IC Rated High Lumen Regressed Specification Sheet

PRODUCT DIAGRAM

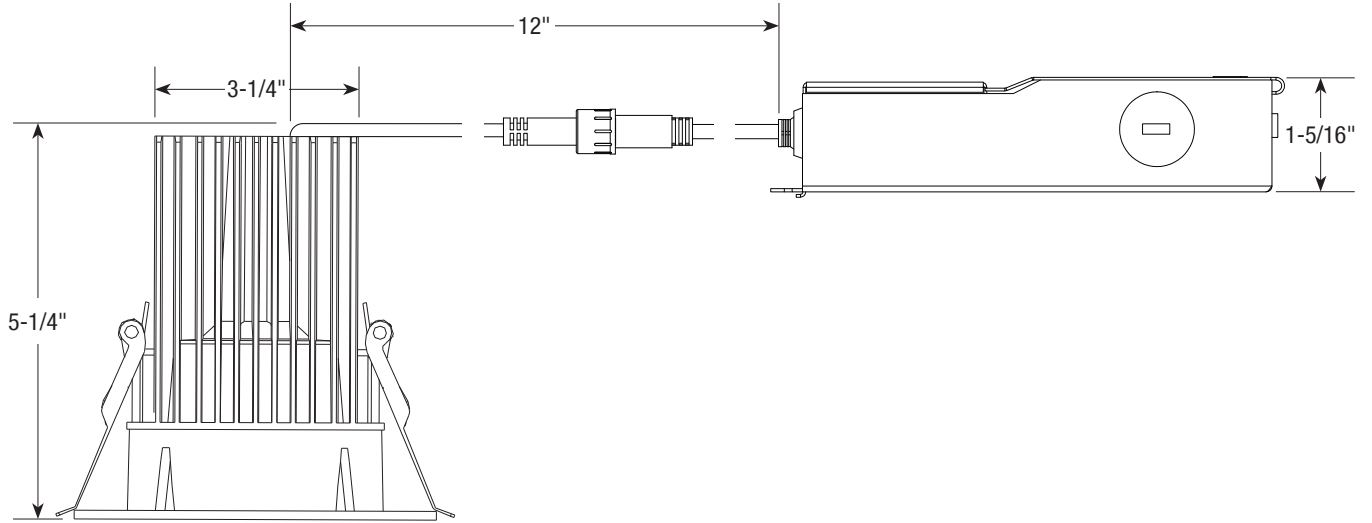

Fixture shown with trim attached

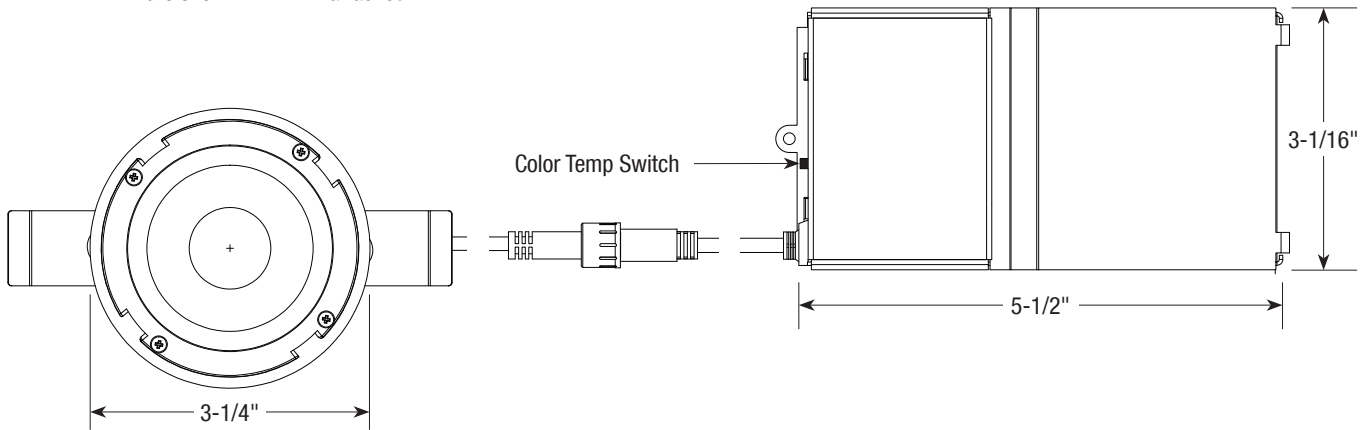

Fixture shown without trim

